

Installation and Operating Guide

FastStor LTO



Copyright Notice

© Copyright ADIC, 2000

The information contained in this document is subject to change without notice.

This document contains proprietary information which is protected by copyright. All rights are reserved. No part of this document may be photocopied, reproduced, or translated to another language without the prior written consent of ADIC.

ADIC shall not be liable for errors contained herein or for incidental or consequential damages (including lost profits) in connection with the furnishing, performance or use of this material whether based on warranty, contract, or other legal theory.

Printed in the USA

January 2001

Document Number 62-2211-01 Rev B

Advanced Digital Information Corporation

Telephone: (425) 881-8004

Fax: (425) 881-2296

World-Wide Web: <http://www.adic.com>

Shipping Address: 11431 Willows Road NE
Redmond, WA 98052

Mailing Address: PO Box 97057
Redmond, WA 98073-9757

ADIC Europe

ZAC des Basses Auges

1, rue Alfred de Vigny

78112 – Fourqueux, FRANCE

Telephone: +33 (0)1 30 87 53 00

Fax: +33 (0)1 30 87 53 01

For Customer Assistance:

In the United States and Canada, call ADIC Technical Assistance Center (ATAC) at (800) 827-3822

In Europe, call ADIC Technical Assistance Center (ATAC) at +800.9999.3822

ADIC™, ADIC Europe™, and FastStor™ are trademarks of Advanced Digital Information Corporation. Linear Tape Open™, LTO™, Ultrium™, and the Ultrium logo are trademarks of Hewlett Packard, IBM, and Seagate in the United States. All other names should be considered trademarks of their respective owners.

Copyright Notice (Europe)

© *Copyright 2000, ADIC Europe*

All rights reserved. No part of this document may be copied or reproduced in any form or by any means, without prior written permission of ADIC Europe, ZAC des Basses Auges, 1, rue Alfred de Vigny, 78112 – Fourqueux, FRANCE.

ADIC Europe assumes no responsibility for any errors that may appear in this document, and retains the right to make changes to these specifications and descriptions at any time, without notice.

This publication may describe designs for which patents are pending, or have been granted. By publishing this information, ADIC Europe conveys no license under any patent or any other right.

ADIC Europe makes no representation or warranty with respect to the contents of this document and specifically disclaims any implied warranties of merchantability or fitness for any particular purpose. Further, ADIC Europe reserves the right to revise or change this publication without obligation on the part of ADIC Europe to notify any person or organization of such revision of change.

Every effort has been made to acknowledge trademarks and their owners. Trademarked names are used solely for identification or exemplary purposes; any omissions are made unintentionally.

ADIC Europe is a trademark of ADIC.

Regulatory Notices

FCC Notices (USA Only)

This equipment generates, uses, and can radiate radio frequency energy and, if not installed and used in accordance with the manufacturer's instruction manual, may cause interference with radio and television reception. This equipment has been tested and found to comply with the limits for a Class B digital device, pursuant to Part 15 of the FCC Rules. These limits are designed to provide reasonable protection against harmful interference in a residential installation. However, there is no guarantee that interference will not occur in a particular installation. If this equipment does cause harmful interference with radio or television reception, which can be determined by turning the equipment off and on, you are encouraged to try to correct the interference by one or more of the following measures:

Reorient the receiving antenna.

Relocate the equipment with respect to the receiver.

Move the equipment away from the receiver.

Plug the equipment into a different outlet so that the equipment and the receiver are on different branch circuits.

If necessary, consult a representative of ADIC or an experienced radio/television technician for additional suggestions. You may find the following booklet helpful: FCC Interference Handbook, 1996, available from the U.S. Government Printing Office, Washington, DC 20402, Stock No. 004-000-00450-7.

This device complies with Part 15 of the FCC rules. Operation is subject to the following two conditions:

This device may not cause harmful interference.

This device must accept any interference received, including interference that may cause undesired operation.

A Notice About Shielded Cables: Use only shielded cables for connecting peripherals to this device to reduce the possibility of interference with radio and television reception. Using shielded cables ensures that you maintain the appropriate FCC radio frequency emissions compliance (for a Class A device) or FCC certification (for a Class B device) of this product.

The following information is provided on the device or devices covered in this document in compliance with FCC regulations:

Product Name: *FastStor*
Model number: *FS-LTO*
Company name: *Advanced Digital Information Corporation*
 PO Box 97057
 Redmond, WA 98073-9757 USA
 (425) 881-8004

IC Notice (Canada Only)

Most tape libraries are classified by the Industry Canada (IC) Interference-Causing Equipment Standard #3 (ICES-003) as Class B digital devices. To determine which classification (Class A or B) applies to your tape library, examine all registration labels located on the bottom or the back panel of your library. A statement in the form of "IC Class A ICES-3" or "IC Class B ICES-3" will be located on one of these labels.

Note that Industry Canada regulations provide that changes or modifications not expressly approved by the tape library manufacturer could void your authority to operate this equipment.

This Class B (or Class A, if so indicated on the registration label) digital apparatus meets the requirements of the Canadian Interference-Causing Equipment Regulations.

Cet appareil numérique de la Classe B (ou Classe A, si ainsi indiqué sur l'étiquette d'enregistrement) respecte toutes les exigences du Règlement sur le Matériel Brouilleur du Canada.

EN 55022 Compliance (Czech Republic Only)

This device belongs to category B devices as described in EN 55022, unless it is specifically stated that it is a category A device on the specification label. The following applies to devices in category A of EN 55022 (radius of protection up to 30 meters). The user of the device is obliged to take all steps necessary to remove sources of interference to telecommunication or other devices.

Pokud není na typovém štítku pořízeno uvedeno, že spadá do třídy A podle EN 55022, spadá automaticky do třídy B podle EN 55022. Pro zařazení zařízení do třídy A (ochranné pole 30m) podle EN 55022 platí následující. Dojde-li k rušení telekomunikačních nebo jiných zařízení, je uživatel povinen provést takové opatření, aby rušení odstranil.

CE Notice

Marking by the symbol **CE** indicates compliance of this tape library to the EMC (Electromagnetic Compatibility) directive of the European Community. Such marking is indicative that this tape library meets or exceeds the following technical standards:

EN 55022 — “Limits and Methods of Measurement of Radio Interference Characteristics of Information Technology Equipment.”
This system is an EN 55022 Class B device.

EN 50081-1 — “Electromagnetic compatibility—Generic emission standard Part 1: Residential, commercial, and light industry.”

EN 50082-1:1997 — “Electromagnetic compatibility—Generic immunity standard Part 1: Residential, commercial, and light industry.”

EN 61000-3-2 — “Harmonic current emissions test.” — Device Class A.

EN 61000-3-3 — “Voltage fluctuations and flicker in low-voltage supply systems test.”

EN 61000-4-2 — “Electrostatic discharge immunity test.” — Severity level 3.

EN 61000-4-3 — “Radiated, radio-frequency, electromagnetic field immunity test.” — Severity level 2.

EN 61000-4-4 — “Electrical fast transient/burst immunity test.” — Severity level 2.

EN 61000-4-5 — “Surge immunity test.” — Severity level 2.

EN 61000-4-6 — “Immunity to conducted disturbances, induced by radio-frequency fields.” — Severity level 2.

EN 61000-4-8 — “Power frequency magnetic field immunity test.” — Severity level 2.

EN 61000-4-11 — “Voltage dips, short interruptions and voltage variations immunity test.” — Performance criteria B and C.

ENV 50204 — “Radiated electromagnetic field from digital radio telephones.”

EN 60950:1992 + Amd.1:1993 + Amd.2:1993 with considerations to Amd.3:1995 — “Safety of Information Technology Equipment including Electrical Business Equipment.”

A “Declaration of Conformity” in accordance with the preceding standards has been made and is on file at ADIC Europe, ZAC de Basses Auges, 1, rue Alfred de Vigny, 78112 Fourqueux, FRANCE.

VCCI Notices (Japan Only)

This is a Class B product based on the standard of the Voluntary Control Council for Interference for information technology equipment. If this equipment is used near a radio or television receiver in a domestic environment, it may cause radio interference. Install and use the equipment according to the instruction manual.

Note that VCCI regulations provide that changes or modifications not expressly approved by the tape library manufacturer could void your authority to operate this equipment.

DECLARATION OF CONFORMITY

according to EN 45014

Manufacturer's Name: Advanced Digital Information Corporation

Manufacturer's Address: 11431 Willows Road ZAC des Basses Auges
Redmond, Washington 98052 1, rue Alfred de Vigny
USA 78112 Fourqueux,
FRANCE

declares, that the product:

**Product
(Produit, Erzeugnis):** FastStor

**Model Numbers
(Marque Commercial,
Warenbezeichnung):** FS-LTO

conforms to the following international standards,

Emissions: CISPR 22:1997 Class B, EN 61000-3-2, -3

Immunity: EN 55024:1998

Safety: IEC 60950:1991+A1/A2/A3/A4

Quality: ISO 9001:1994

Supplementary Information:

Signature: _____
Signature on File

Signature: _____
Signature on File

Full Name: _____

Full Name: _____

Position: _____

Position: _____

Date: _____

Date: _____

Place: Redmond, WA USA

Place: Fourqueux, FRANCE

Safety Notices

Warnings



This symbol should alert the user to the presence of "dangerous voltage" inside the product that might cause harm or electric shock.

CAUTION

**RISK OF ELECTRIC SHOCK
DO NOT OPEN**

CAUTION : TO REDUCE THE RISK OF ELECTRIC SHOCK, DO NOT REMOVE COVER (OR BACK). NO USER-SERVICEABLE PARTS INSIDE. REFER SERVICING TO QUALIFIED SERVICE PERSONNEL.

Caution

All safety and operating instructions should be read before this product is operated, and should be retained for future reference. This unit has been engineered and manufactured to assure your personal safety. Improper use can result in potential electrical shock or fire hazards. In order not to defeat the safeguards, observe the following basic rules for its installation, use and servicing.

- Heed Warnings - All warnings on the product and in the operating instructions should be adhered to.
- Follow Instructions - All operating and use instructions should be followed.
- Ventilation - The product should be situated so that its location or position does not interfere with proper ventilation.
- Heat - The product should be situated away from heat sources such as radiators, heat registers, furnaces, or other heat producing appliances.
- Power Sources - The product should be connected to a power source only of the type directed in the operating instructions or as marked on the product.
- Power Cord Protection - The AC line cord should be routed so that it is not likely to be walked on or pinched by items placed upon or against it, paying particular attention to the cord at the wall receptacle, and the point where the cord exits from the product.
- Object and Liquid Entry - Care should be taken to insure that objects do not fall and liquids are not spilled into the product's enclosure through openings.
- Servicing - The user should not attempt to service the product beyond that described in the operating instructions. All other servicing should be referred to qualified service personnel.

Precautions

- Do not use oil, solvents, gasoline, paint thinners or insecticides on the unit.
- Do not expose the unit to moisture, to temperatures higher than 60°C (140°F) or to extreme low temperatures.
- Keep the unit away from direct sunlight, strong magnetic fields, excessive dust, humidity and electronic/electrical equipment, which generate electrical noise.
- Hold the AC power plug by the head when removing it from the AC source outlet; pulling the cord can damage the internal wires.
- Use the unit on a firm level surface free from vibration, and do not place anything on top of unit.

Blank Page

Table of Contents

Copyright Notice.....	ii
Copyright Notice (Europe).....	iii
Regulatory Notices.....	iv
Safety Notices.....	vii
Quick Start Guide.....	xi
Chapter 1_Toc505137412_Introduction.....	1
Equipment Description.....	2
Features.....	3
LTO Drives.....	3
Switches and Indicators.....	4
LTO Tape Media.....	6
Write-Protect Switch.....	6
Other Requirements.....	7
SCSI Host Adapter.....	7
Application Software.....	7
Chapter 2 Hardware Installation.....	9
Unpacking and Inspecting.....	10
Checking the Accessories.....	10
Installing the Host Adapter.....	10
Installing the SCSI Cable and Terminator.....	11
Connecting More than One FastStor LTO.....	12
Preparing the Host Computer System.....	12
Installing the Application Software.....	12
Chapter 3 Operation and Maintenance.....	13
Normal Operations.....	14
General Guidelines.....	14
Powering on the System.....	14
Power Up Checks.....	15
Setting the SCSI IDs.....	15
Prepare and Install the Data Cartridges.....	17
Close and Lock the Front Door.....	18
Drive Status Messages.....	18
FastStor LTO Modes.....	19
Mode 1A – LOAD DRV.....	20
Mode 1B – EJECT DRV.....	21
Mode 2 – LOAD SLOT.....	22
Mode 3 – EJECT SLOT.....	23
Mode 4 – EJECT PCKR.....	24
Mode 6 – SET SCSI ID.....	24
Normal Maintenance.....	27
Cleaning the Drive Head.....	27
Cleaning Tape.....	27
Drive Head Cleaning Procedure.....	27
Cleaning the Enclosure.....	28
Chapter 4 Troubleshooting and Diagnostics.....	29
Installation Problems.....	30
Loader and Drive Operational Problems.....	30
DIAGNOSTIC MENU.....	31
DISPLAY FIRMWARE.....	32
SIGN ON.....	34
CHANGE MODE.....	35
CYCLE TEST.....	36
CLEAN DRIVE.....	37
AUTOCLEAN.....	38
Enabling AUTOCLEAN.....	38
Using AUTOCLEAN.....	39
Disabling AUTOCLEAN.....	40
UPGRADE LOADER FIRMWARE.....	41

DISPLAY COUNTS	43
UPGRADE DRIVE FIRMWARE	44
DRV MAINT	45
DRV DIAGS	46
DSPLY ERLG.....	47
CLR ERRLOG	48
DRV DUMP.....	48
DUMPTOTAPE.....	49
DRV POST	50
FastStor LTO Error Messages.....	51
Error Message Listing.....	51
Drive Error Codes	52
Environmental Considerations	53
When You Call ADIC'S Technical Assistance Center	53
Appendix Specifications	55
Appendix B	57
Index	63

Quick Start Guide

This Guide ...

- provides a quick guide for experts who are familiar with installing hardware and software.

Follow these steps to quickly get started using your ADIC FastStor LTO:

Notes

The following defaults have been set at the factory, and in most cases, should not have to be changed.

- LDR SCSI ID: 1, DRV SCSI ID: 3
- Operating Mode: Random
- Logon String: ADIC FastStor

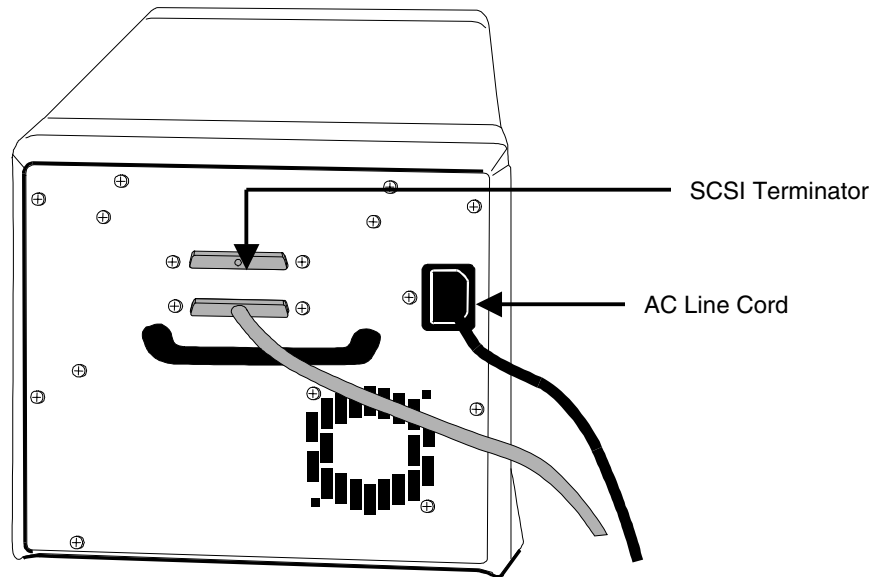

1. Install AC line cord, first to your FastStor LTO, then to AC outlet.
2. Install SCSI terminator on your FastStor LTO.

3. Power up your FastStor LTO by pressing the Power button.

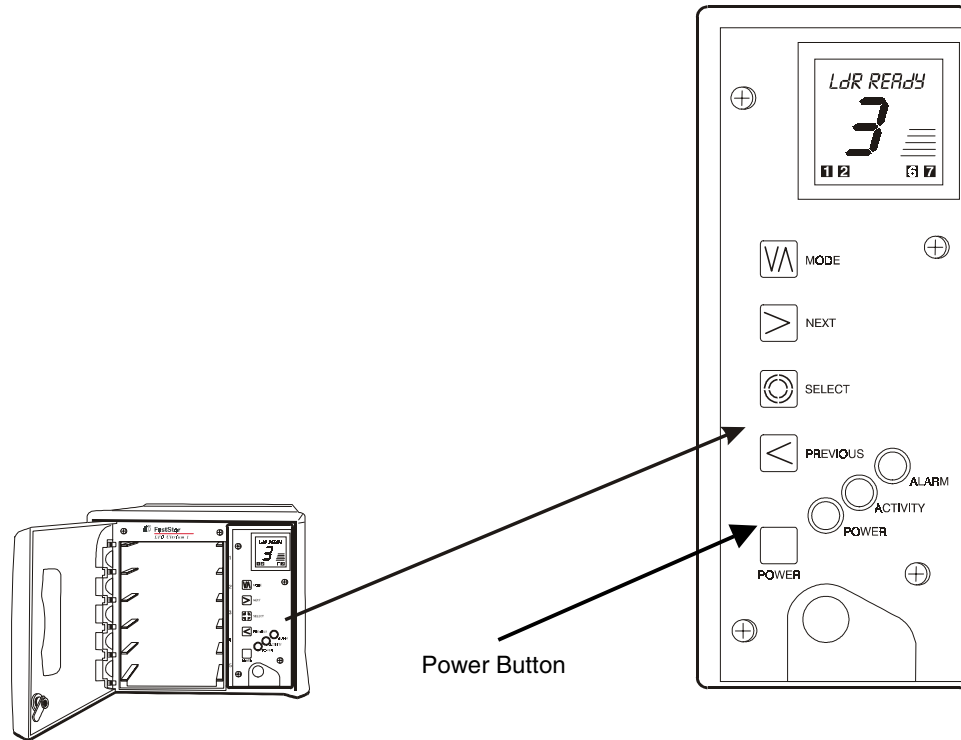

4. Install data cartridges in slots 1 through 5 of your FastStor LTO.

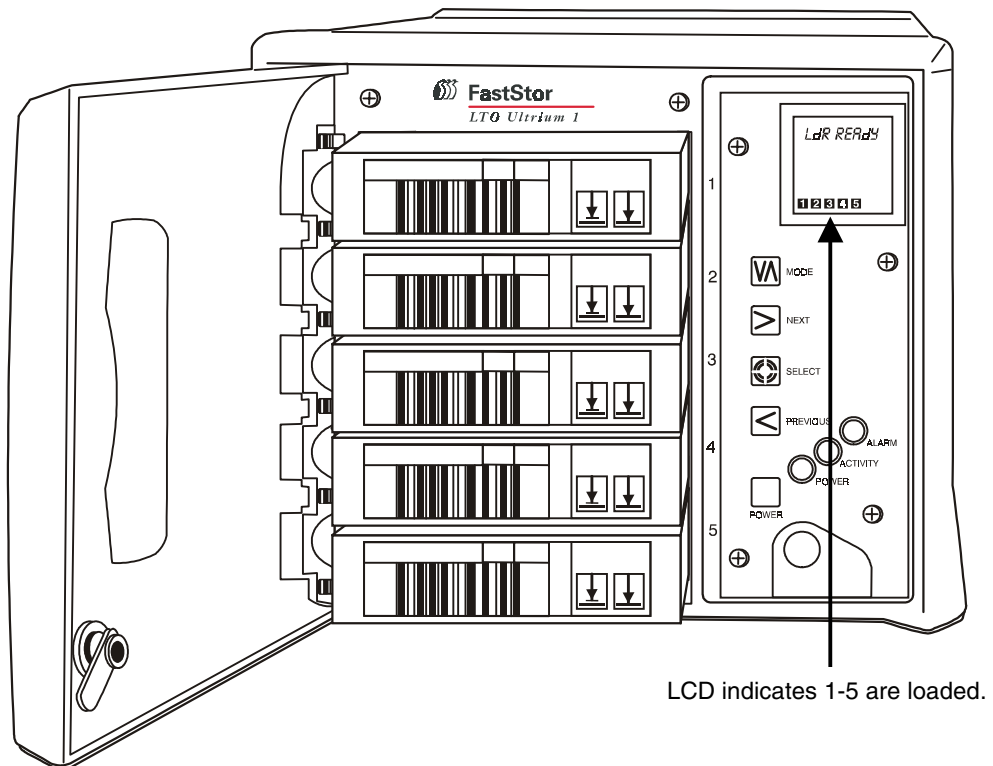

- Using the Mode Menu, move the cartridge from slot 1 to slot 6, and from slot 2 to slot 7.

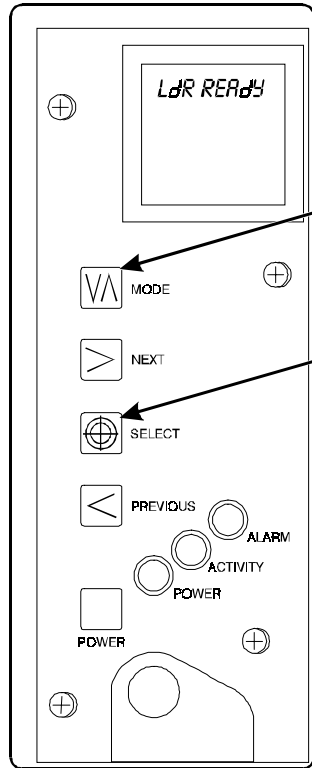

Press MODE button until LOAD SLOT is displayed.

Press SELECT button twice. Tape in slot 1 will move to slot 6.

Repeat above steps to move tape in slot 2 to slot 7.

- Install additional data cartridges in slots 1 and 2.

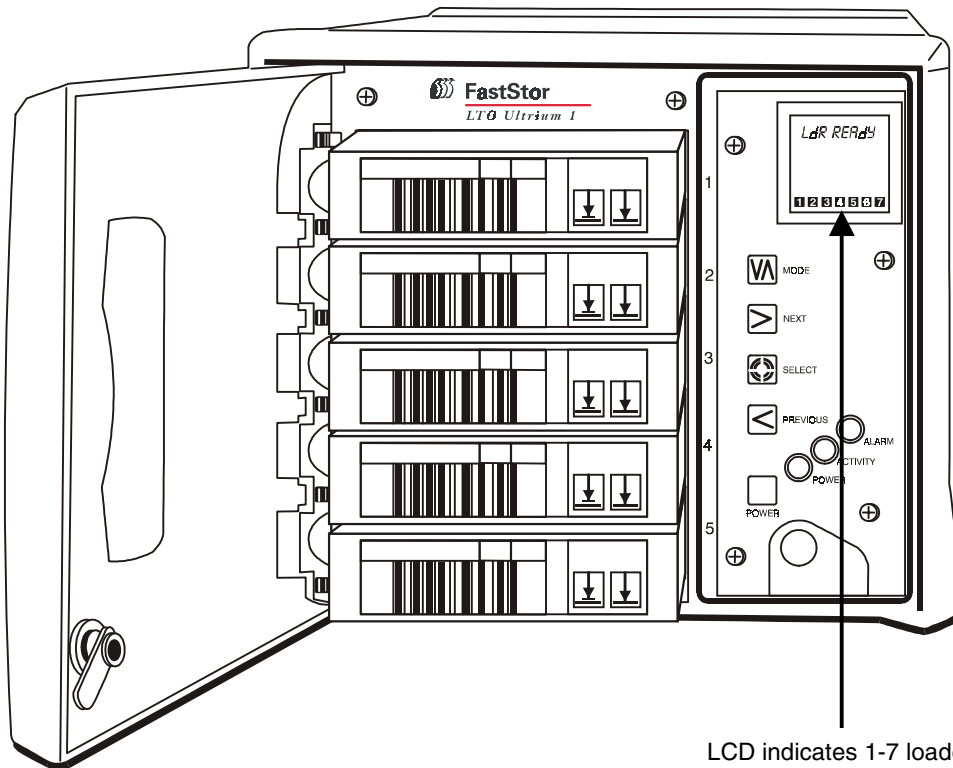

LCD indicates 1-7 loaded.

-
7. Connect SCSI cable to rear of FastStor LTO and to SCSI adapter on your host computer.

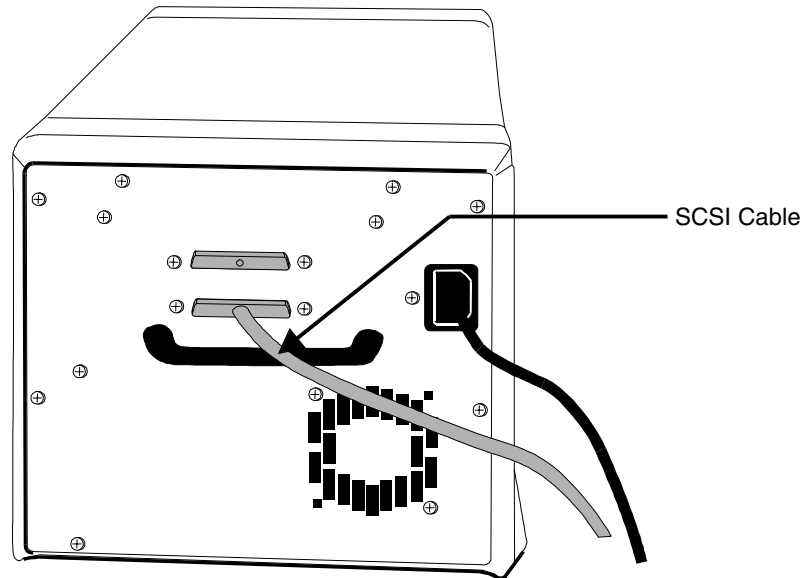

8. Power up your host computer.
9. Verify your backup software.

Your ADIC FastStor LTO is ready for operation.

Blank Page

Chapter 1

Introduction

This Chapter ...

- provides a physical description of the switches, indicators and connectors on the front and rear panels of the external FastStor LTO
- describes the drive and media used in the FastStor LTO
- describes other requirements (additional hardware and/or software) needed to utilize the FastStor LTO
- provides a brief overview of the FastStor LTO features. For detailed specifications, see Appendix A

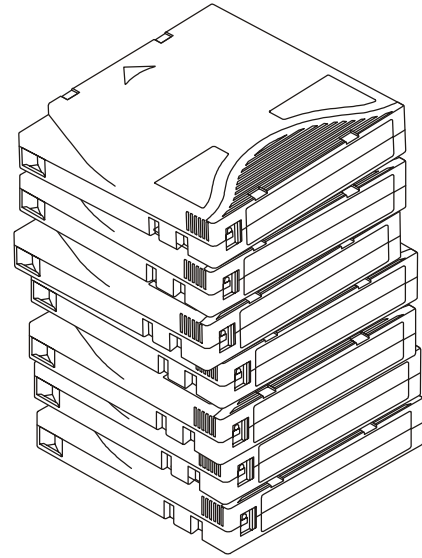
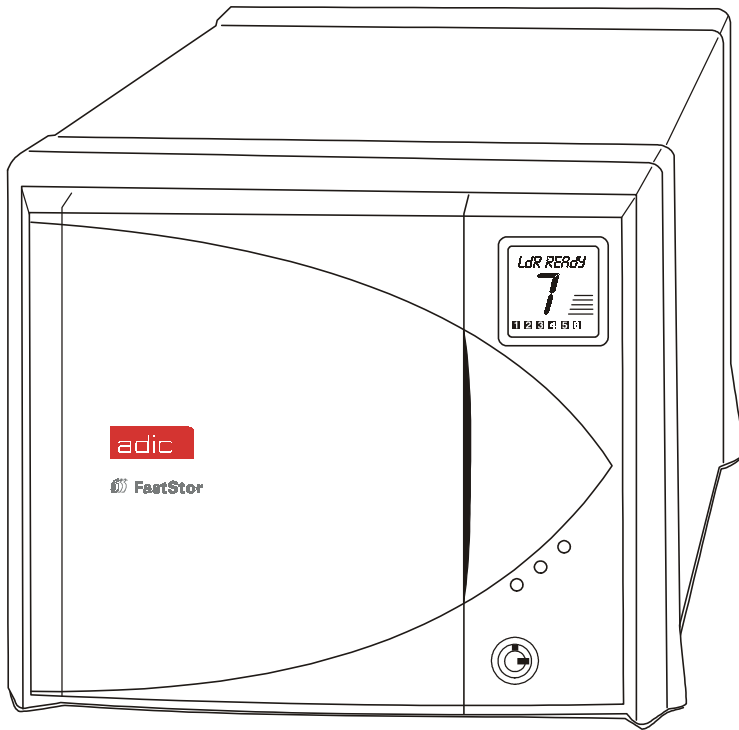

Welcome to your ADIC FastStor LTO (shown above). Your FastStor LTO is a fully automated, high-performance, high-capacity, mass storage system. The FastStor LTO is designed to provide you with unattended, near-line and off-line data storage, archiving, backup, hierarchical storage management (HSM), and retrieval for low- and mid-range servers and networks. Through the remainder of this manual, references will be made to the FastStor LTO. Except in model-specific instances (the reference will be made to the proper model), the information is applicable to all models of the family. **FastStor LTO products can only be rackmounted in a FastStor LTO 5U Rackmount Kit.**

Equipment Description

The FastStor LTO is a SCSI compatible and economical data storage device. The FastStor LTO incorporates a streaming tape cartridge data storage device, which features high capacity, high throughput, and data compression. Equipped with an IBM® Ultrium 1 LTO™ drive, your FastStor LTO operates as two SCSI devices on a single SCSI bus. Your FastStor LTO can contain up to 7 data cartridges providing a maximum formatted capacity of 1.4 TB (assuming 2:1 compression) and a sustained data transfer rate as high as 1.8 GB per minute (assuming 2:1 compression). The tape media is rated at 5000 load and unload cycles.

The FastStor LTO is compatible with all operating systems and environments supporting the SCSI interface, but requires either direct support of the operating system or a suitable application program to take advantage of its features. Hosting environments that do not directly support SCSI interfaces, like most personal computers, require the addition of a SCSI Host Adapter card. The FastStor LTO is available with either Ultra 2 Low-Voltage Differential/Single-ended (LVD/SE) SCSI interface or Ultra SCSI, High-Voltage Differential (HVD) SCSI interface. The unit configuration is clearly labeled near the SCSI connectors on the rear panel.

Your FastStor LTO is capable of operating in either Random-Access or Sequential-Access modes. In Random-Access mode, the application software controls cartridge management. In Sequential-Mode, your FastStor LTO operating firmware predefines cartridge management. Refer to the *Change Mode* section in *Chapter 4 Troubleshooting and Diagnostics*, for a detailed description of Sequential-Mode operation.

Features

- ❑ **Multi-function Operator Panel.** The Operator Panel, located to the right, under the front door, employs a 1-line by 10-character liquid crystal display (LCD), a four-key keypad, and three LEDs to permit you to monitor and control the operations of your library. Specific areas of the LCD provide you with information such as: status of the tape storage slots (empty, or data cartridge present); which cartridge is loaded into the drive; status of the cartridge in the drive (write-protected or data compression enabled); and inform you when the drive requires cleaning.
- ❑ **Media Transporter.** The Media Transporter is the media cartridge handling mechanism and normally responds to commands from the application software to move the cartridges between the storage slots and the drive. Employing a bi-directional, pass-through gripper, the Media Transporter picks and places cartridges to/from the front and rear mounted storage slots.
- ❑ **FastStor DLT Emulation.** To maximize application software compatibility, your FastStor LTO shares the same command set as the ADIC FastStor DLT, and can appear as either a FastStor LTO or a FastStor DLT.
- ❑ **System Integrity.** The cartridge storage slots, drive, and robotics are protected by a physically lockable door.
- ❑ **Cleaning Cartridge.** Although the cleaning cartridge can occupy a cartridge storage slot in the FastStor LTO (facilitating automated cleaning cycles), manual insertion of a cleaning cartridge is permitted by opening the front door and installing the cleaning cartridge into any slot for application use, or slot 2 for manual use.
- ❑ **Manual Cartridge Use.** Individual cartridges can easily be transported to the drive by manually opening the front door and installing the cartridge into any unoccupied storage slot. The Operator Panel is then used to load cartridges to the drive.
- ❑ **Cartridge Pre-Check.** Whenever you power up your FastStor LTO it will scan the cartridge storage slots and the drive and build a log of valid cartridge locations.
- ❑ **Reverse Cartridge Protection.** The five front cartridge storage slots employ a design that prevents the cartridges from being inserted incorrectly.
- ❑ **Built-in Diagnostics.** Your FastStor LTO includes diagnostic firmware that tells you when drive head cleaning is required, reports diagnostic results, and drive operating status.
- ❑ **Barcode Ready.** The available barcode reader option delivers instant media verification and inventory.
- ❑ **24 Hour Fast Exchange.** In the event your FastStor LTO needs to be serviced, ADIC will provide you with a next day advanced exchange to reduce down time.

LTO Drives

Your ADIC FastStor LTO is equipped with an IBM manufactured LTO Ultrium I drive and a corresponding robotics interface. Your FastStor LTO is configured with either a LVD/SE Ultra-2 SCSI interface, or HVD Ultra SCSI interface.

Switches and Indicators

The following figures shows the switches and indicators located on the front and rear panels of the FastStor LTO.

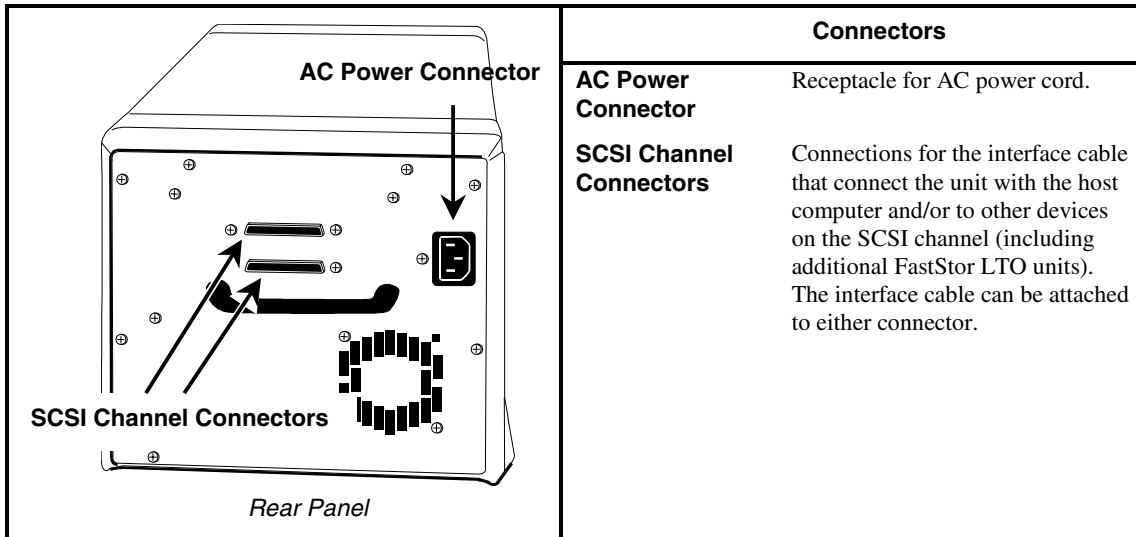

The Operator's Panel is located behind the front door of the FastStor LTO . If necessary, unlock the door to access the Operator's Panel.

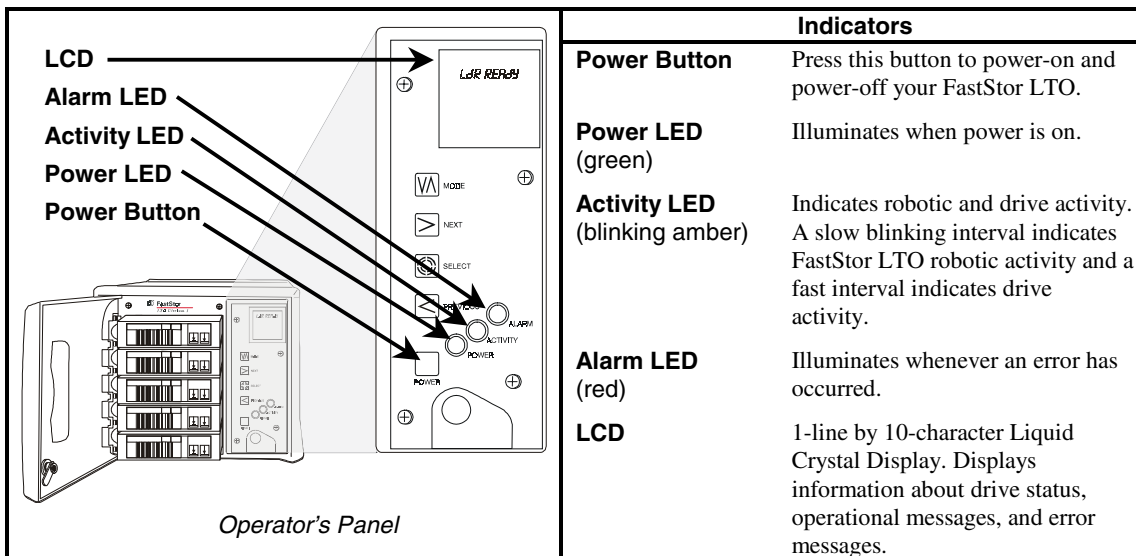

Indicators

The following illustration shows the layout of the LCD. The normal on-line message (**LdR REAdY**) is displayed on the top line. On-line, off-line, and error messages also appear on this line.

DC indicates data compression is selected on the drive.
WP indicates a write-protected data cartridge is loaded into the drive.
CT indicates the drive head needs to be cleaned.

The large field in the center of the display normally indicates which cartridge is loaded into the drive. Whenever an error occurs an **E** will appear in this field and the error message will appear on line 1.

The Activity Bars on the right side of the display, in conjunction with the Activity LED, indicate robotic and drive activity. A blinking bottom bar is displayed when no activity is taking place. A slow interval between the bars appearing/ disappearing indicates robotic activity, and a fast interval indicates drive activity.

LCD

The seven numeric fields at the bottom of the display indicate the current cartridge inventory. Each will appear only if a cartridge is present in the appropriate storage slot.

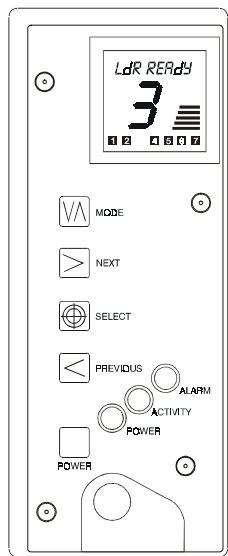

Operator's Panel

Controls

MODE	Press this button to enter or exit off-line mode menus.
NEXT	Selects next item or value in the currently displayed menu.
SELECT	Causes the FastStor LTO to execute the current menu (displayed on line 1 of the LCD).
PREVIOUS	Selects previous item or value in the currently displayed menu.
POWER	Press and release this button to turn on your LTO Autoloader. Press and hold this button for 2 seconds to turn off your FastStor LTO. POWER DOWN will appear on the LCD and the Activity Bars (see Indicators above) and Activity LED will indicate robotic activity as the Picker moves to its power down position.

LTO Tape Media

To insure proper operation of your FastStor LTO, use only LTO-certified data cartridges.

Whenever possible, store the LTO Data Cartridge in the following room-environment conditions:

- Temperature of 20 C, 5C (68 F, 9 F)
- Relative humidity of 50% (20%)

Recommended Environment			
Environmental Factor	Operating	Storage	Shipping
Temperature	10 C to 40 C (50 F to 104 F)	16 C to 32 C (61 F to 90 F)	-23 C to 49 C (-9 F to 120 F)
Relative humidity (noncondensing)	20% to 80%	20% to 80%	20% to 80%
Wet bulb temperature	26 C (79 F)	26 C (79 F)	26 C (79 F)

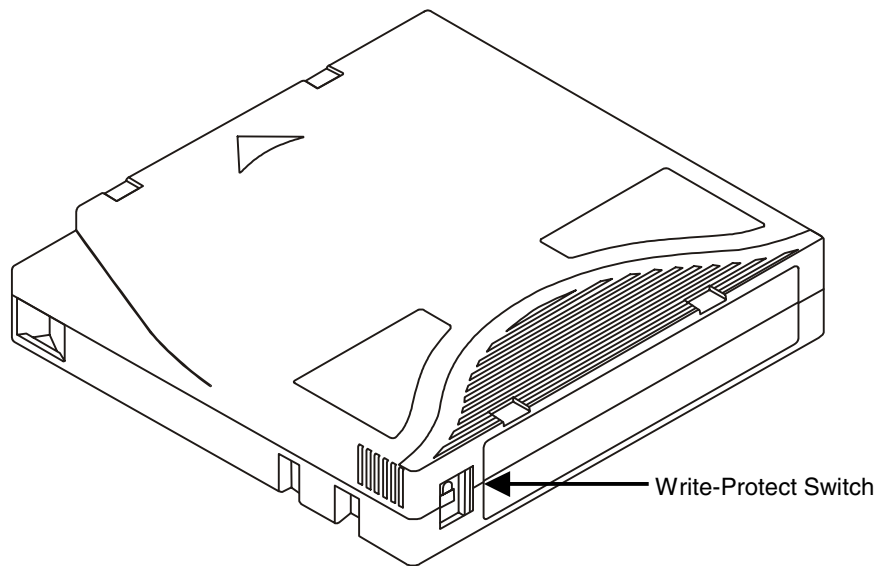

The data cartridges used in the LTO Ultrium drive are housed in plastic cases and employ ½-inch metal particle tape that has a native capacity of 100GB, and a compressed capacity of 200GB (assuming average 2:1 compression). The cartridge also contains a Linear Tape Open Cartridge Memory (LTO-CM) chip, which contains information about the cartridge and the tape (such as the name of the manufacturer who created the tape, the cartridge's volume serial (volser) number, statistical information about the cartridge's use, and a directory of the data on the tape).



LTO Data Cartridge

Write-Protect Switch

The write-protect switch is used to prevent recording over existing data. To prevent recording or deleting, set the write-protect switch to the closed position (☐). The drive senses the position of the switch and will not allow writing in this position. When installing cartridges in the FastStor LTO, place the switch in the open position (☐), unless you do not wish to record on a specific cartridge. To set the write-protect switch, slide it left or right to the desired position.

- If the switch is set to  data cannot be written to the tape.
- If the switch is set to  data can be written to and read from the tape.

Other Requirements

SCSI Host Adapter

Your FastStor LTO must be connected to either an integrated SCSI host or a separate SCSI interface (host adapter) card installed in the computer – either directly to the I/O connector on the card or as part of an existing SCSI chain. The host adapter you choose will depend on your system requirements and your needs. The SCSI interface must be installed before you connect the FastStor LTO.

Note

Your FastStor LTO requires a connection to either a LVD/SE Ultra-2 or HVD UltraSCSI host. If you are not sure about your host adapter requirements, please call ADIC's Technical Assistance Center (ATAC) and ask for assistance.

Application Software

A variety of backup and data storage software is available for use with your FastStor LTO. The software you use will depend upon your storage needs and the system you are using. Please check with ADIC Sales or Customer Assistance if you have a question on the compatibility of a particular software package.

Now you are ready to connect the FastStor LTO to your host computer. Follow the instructions provided in the next chapter.

Blank Page

Chapter 2

Hardware Installation

This Chapter. . .

- explains the steps necessary to install and test your FastStor LTO

For the most part, installation is simply a matter of checking all necessary SCSI connections, installing the application software (backup or otherwise) on the host computer, and applying power. The FastStor LTO defaults set at the factory should be sufficient for most applications.

Unpacking and Inspecting

Caution

If the operating environment differs from the storage environment by 15° C (30° F) or more, let the unit acclimate to the surrounding environment for at least 12 hours.

- Unpack all items from the carton. Save the packing materials in case you need to move or ship the system in the future.

Caution

You must ship the FastStor LTO in the original or equivalent packing materials or your warranty may be invalidated.

Checking the Accessories

Check to make certain that the following items are included with your FastStor LTO:

- Power cord
- One SCSI cable with 68-pin HD/ 68-pin HD connectors
- One active 68-pin SCSI bus terminator
- This manual
- A Warranty Registration card with free LTO Cleaning Tape coupon
- Two keys for the front door
- ✓ None of the items should show signs of damage.

Installing the Host Adapter

At this point if your host computer system does not have native SCSI capability and the host adapter you are using is not installed, please install it. Refer to the manual that came with your host adapter for specific directions.

When the host adapter card is installed return to this point in the manual.

Installing the SCSI Cable and Terminator

Notes

- Make sure that the interface cable you are planning on using has the appropriate connectors on each end. The FastStor LTO employs a 68-pin high-density SCSI connector on the rear panel.
- If your host computer's SCSI connector is different from that on the FastStor LTO, you will need to obtain an adapter or a different cable. Consult your dealer or ATAC if you need help.
- The interface cable must be shielded – ADIC can supply you with the correct type.

- If your FastStor LTO is the last device on the SCSI bus, install the SCSI terminator onto the remaining SCSI connector on the rear panel of the FastStor LTO.

Note

SCSI bus TERM POWER is supplied by the robotics interface, not by the drive.

- Connect the SCSI cable to either of the SCSI connectors on the rear panel of the FastStor LTO.

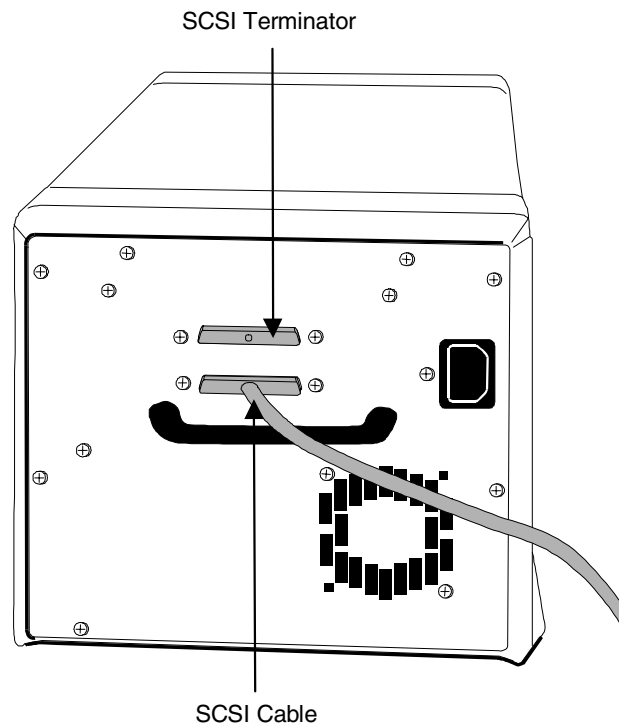

FastStor LTO Rear Panel

- Connect the free end of the SCSI cable to the connector on the host computer's SCSI adapter.
- If you wish to connect one or more additional devices to the bus after the FastStor LTO, connect an appropriate cable between the remaining SCSI connector on the rear panel of the FastStor LTO and the next device.
- Be sure that the bus is terminated at the last device in the chain.
- Make sure that the SCSI cable between the host adapter and the FastStor LTO is secure and the connections are fastened correctly.

Connecting More than One FastStor LTO

If you are connecting more than one FastStor LTO on the same SCSI channel, simply connect each unit to the previous unit with an additional shielded interface cable. You may use either SCSI connector on the rear of on each of your FastStor LTO units.

Make sure that you configure each FastStor LTO unit with a unique drive SCSI ID and loader ID. Your FastStor LTO units will not function properly if they have the same SCSI IDs.

Preparing the Host Computer System

Installing the Application Software

At this point you need to refer to your software installation guide for instructions on installing the backup/controlling software for the FastStor LTO onto the host computer.

Chapter 3

Operation and Maintenance

This Chapter. . .

- describes normal operating features of your FastStor LTO
- provides details on the media and drive head cleaning cartridge
- explains normal maintenance procedures

Normal Operations

General Guidelines

Once your FastStor LTO and your choice of application software are installed and configured, you can automatically perform backup and restore operations through the application software. You do not need to intervene unless you need to replace cartridges.

Always follow these general operating guidelines:

- Do not open the front door of the FastStor LTO unless you must perform manual Mode commands, or change media.
- Use only the recommended types of media cartridges, described earlier in this manual.
- Clean the LTO drive whenever the **CT** field appears on the LCD (signifying a cleaning request), or as soon possible.

Note

Never insert or remove cartridges from the storage slots unless LdR REAdY is displayed on the LCD.

Powering on the System

The two keys for the front door are taped to the rear panel of your FastStor LTO model.

- Remove the keys from the rear panel, unlock and open the front door.
- Remove the foam shipping block from the cartridge area.
- Plug the power cord into the AC receptacle on the rear panel of your FastStor LTO.
- Plug the power cord from the FastStor LTO into a grounded electrical outlet.

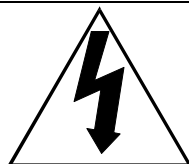

Use caution when plugging the power cord into an electrical outlet. Hazardous voltages are present in the sockets of the outlet.

- Plug the power cord from your host computer into a grounded electrical outlet.
- Turn on power to the FastStor LTO by pressing the **POWER** button on the Operator Panel.

Note

When powering off your FastStor LTO, you must press and hold the POWER button for 2 seconds.

While the FastStor LTO initializes, the LCD will appear as shown below. The Activity LED will blink slowly, and the Activity Bars will appear on the LCD.

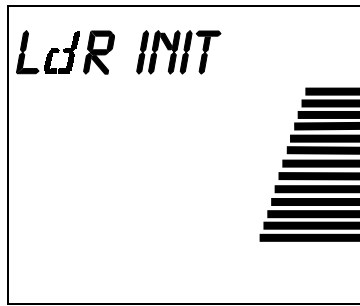

At the completion of FastStor LTO initialization, the drive will initialize and the LCD will appear as shown below. The Activity LED will blink fast, and the Activity Bars will appear on the LCD.

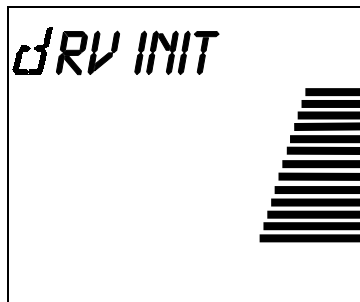

At the conclusion of drive initialization, the LCD will appear as shown below:

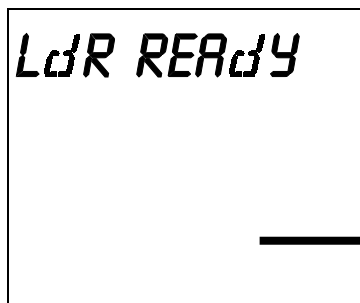

Power Up Checks

When you apply power to your FastStor LTO it will perform the following actions:

- Verify drive configuration and status.
- Build a valid cartridge inventory log.
- Calibrate the Media Picker.

When the FastStor LTO has completed the Power Up Checks, the LCD will display LdR REAdY.

Setting the SCSI IDs

Notes

- The default settings for the SCSI IDs are: LdR Id 1, and dRV Id 3.
 - SCSI ID changes **are not** effective until power has been cycled on the FastStor LTO.
-

Your FastStor LTO consists of two SCSI devices; the drive and the robotics. Depending upon your requirements, you may need to change the SCSI ID default settings for your installation. To change the SCSI ID of the robotics and/or the drive, perform the following steps:

- Repeatedly press the **MODE** button on the Operator's Panel until **SET SCSI (Mode 6)** appears on the first line of the LCD.
- Press the **SELECT** button. **LdR SCSI** will now appear on the LCD.
- Press the **SELECT** button to select the robotics. **LdR Id X** (where **X** is the current SCSI ID of the robotics) will now appear on the LCD.
- Press the **NEXT** button to select a higher ID, or the **PREVIOUS** button to select a lower ID.
- Press the **SELECT** button to accept the new ID for the robotics. **dRV SCSI** will now appear on the LCD.
- Press the **SELECT** button. **dRV Id X** (where **X** is the current SCSI ID) will now appear on the LCD.
- Press the **NEXT** button to select a higher ID, or the **PREVIOUS** button to select a lower ID.
- Press the **SELECT** button to accept the new ID for the drive. **CYCLE PWR** (blinking) will now appear on the LCD for approximately 10 seconds.
- Press and hold the **POWER** button for 2 seconds to power down the FastStor LTO.
- Wait a few seconds, then press the **POWER** button again to power up the FastStor LTO. The new SCSI IDs are now in effect.

Note



You may need to power cycle your server and reconfigure your application software for them to see these new IDs as well.

Prepare and Install the Data Cartridges

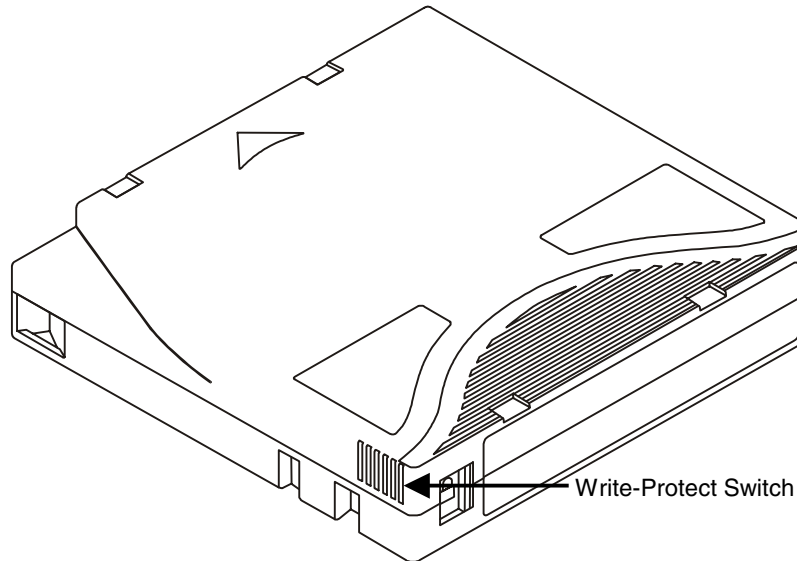
- If necessary, unlock and open the front door to access the cartridge storage slots.
- Make sure that the write-protect switch is set appropriately on each cartridge. Slide the switch to the appropriate position by pushing it with your finger.



LTO Cartridge Write-Protect Switch

- If the switch is set to  data cannot be written to the tape.
- If the switch is set to  data can be written to and read from the tape.

Storage slot 6 and 7 are loaded from slots 1 and 2 respectively, using the Operator's Panel.

Note

Never insert or remove cartridges from the storage slots unless LdR REAdY is displayed on the LCD.

- Place data cartridges into slots 1 and 2.
- Verify that the LCD shows that slots 1 and 2 have tapes present.
- Press the **MODE** button on the Operator's Panel until **LOAD SLOT (Mode 2)** appears on the first line of the LCD.

Note

The LOAD SLOT command always moves the tape from slot 1 to slot 6, and slot 2 to slot 7.

- Press the **SELECT** button to select the **LOAD SLOT** command. **SRC SLOT 1** will now appear on the LCD.
- Press the **SELECT** button to execute the **LOAD SLOT** command.

The FastStor LTO will now move the tape (data cartridge or cleaning tape) from slot 1 to slot 6. While executing, the **LdR MOVE**, **LdR PICK**, and **LdR PLACE** messages will appear on the LCD. When the FastStor LTO has completed the command, **LdR REAdY** will again appear on the LCD.

- Verify that the LCD now shows that slots 2 and 6 have tapes present.
- Press the **MODE** button on the Operator's Panel until **LOAD SLOT (Mode 2)** appears on the first line of the LCD.
- Press the **SELECT** button to select the **LOAD SLOT** command. **SRC SLOT 2** will now appear on the LCD.

-
- Press the **SELECT** button to execute the **LOAD SLOT** command.

The FastStor LTO will now move the tape from slot 2 to slot 7. While the command is executing, the Activity Bars will indicate loader activity, **LdR MOVE**, **LdR PICK**, and **LdR PLACE** messages will appear on the LCD, and the Activity LED on the Operator's Panel will blink slowly. When the FastStor LTO has completed the command, **LdR REAdY** will appear on the LCD.

- Verify that the LCD now shows that slots 6 and 7 now have tapes present.
- Install five additional cartridges into storage slots 1 through 5.
- ✓ Verify that the LCD now shows that slots 1 through 7 have tapes present.

Close and Lock the Front Door

Close the FastStor LTO door, turn the key a quarter-turn clockwise and remove it from the lock.

- Turn on the host computer power and launch the software application.

The application will now control the FastStor LTO. Use the Mode commands, described on the following pages, to manually perform FastStor LTO functions.

Drive Status Messages

During on-line operation, your FastStor LTO will place drive status messages on the top line of the LCD. The following table lists the messages that will appear on the LCD:

Drive Status Message	Description
CALIBRATE	Drive is calibrating head to tracks on tape
EJECTING	Drive is unloading tape
CLEANING	Drive is cleaning head with cleaning cartridge
ERASING	Drive is erasing tape
READING	Drive is reading tape
WRITING	Drive is writing to tape
LOCATING	Drive is locating a position on tape
REWINDING	Drive is rewinding tape

FastStor LTO Modes

The following diagram is a quick reference guide to the Modes described on the next few pages.

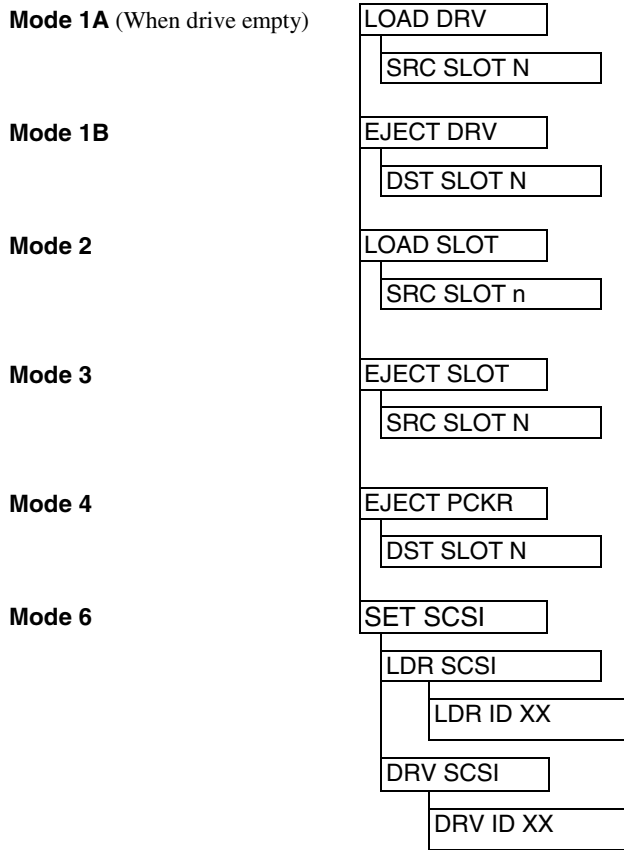

- ☐ To access any of the Modes, press the **MODE** button repeatedly until the LCD displays the desired mode on line 1.

Notes

- It is only possible to scroll forward through the Mode choices. If you pass the mode you desire, continue to press the MODE button until the mode you desire is again displayed on the LCD.
- While accessing Modes 1-6, the FastStor LTO is not available to your software application.

- ☐ To exit any of the Modes and return to LdR READy, press the **MODE** button.

Mode 1A – LOAD DRV

Mode 1A causes your FastStor LTO to load a tape into the drive.

Note

If a tape is already loaded in the drive, Mode 1A is not selectable on the LCD, however, Mode 1B is selectable.

- To access **Mode 1A**, press the **MODE** button until the LCD appears as shown:

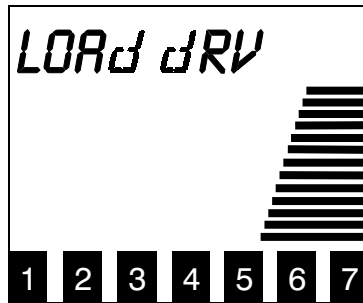

- Press the **SELECT** button to choose this mode. The LCD appears as shown:

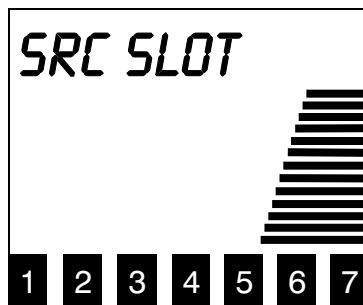

Note

If the source slot is empty, a blinking RESELECT will appear on the LCD. The blinking RESELECT indicates that you attempted to select an invalid source slot.

- ❑ Use the **NEXT** or **PREVIOUS** button to scroll through the slot choices. Press **SELECT** when the slot you wish to load is displayed.

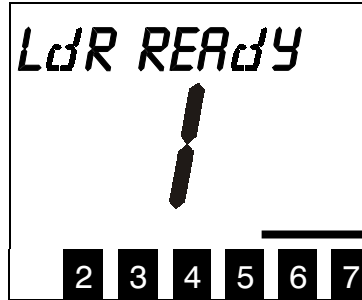

Your FastStor LTO will load the desired tape into the drive. After completing the task, the FastStor LTO will return to LdR REAdY, and the slot number of the tape in the drive will be displayed in the center of the LCD.

Mode 1B – EJECT DRV

Mode 1B causes the FastStor LTO to eject the tape from the drive and place it into the storage slot that it was loaded from.

- ❑ To access **Mode 1B**, press the **MODE** button until the LCD appears as shown:

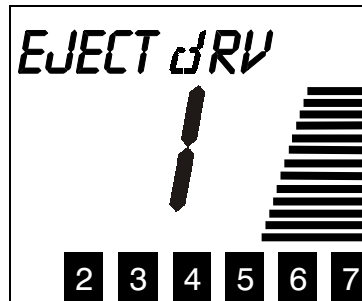

- ❑ Press the **SELECT** button to select **Mode 1B**. The LCD will appear as shown while the drive ejects the tape:

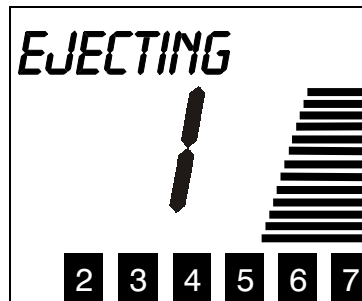

When your FastStor LTO has completed the command, it will return to LdR REAdY.

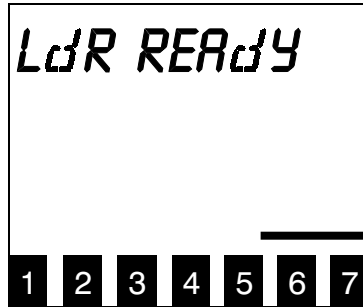

Mode 2 – LOAD SLOT

Mode 2 causes the FastStor LTO to load slot 6 from slot 1, or slot 7 from slot 2.

Note

If slots 6 and 7 already have cartridges, Mode 2 is not selectable on the LCD.

- Place a cartridge in slot 1 if loading slot 6, slot 2 if loading slot 7, or both if loading slots 6 and 7.
- To access **Mode 2**, press the **MODE** button until the LCD appears as shown:

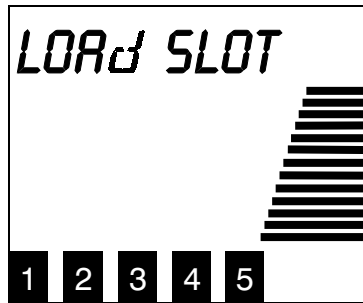

- Press the **SELECT** button to select **Mode 2**. The LCD will appear as shown (N is either slot 1 or 2):

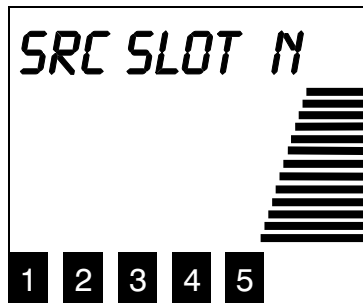

Note

If slots 6 and 7 already have cartridges, Mode 2 is not selectable on the LCD.

- Press the **SELECT** button to move the cartridge from slot 1 to slot 6, or from slot 2 to slot 7. After moving the cartridge FastStor LTO will return to LdR REAdY.

Mode 3 – EJECT SLOT

Mode 3 causes the FastStor LTO to move a tape from slot 6 to slot 1, or from slot 7 to slot 2.

Note

If the source slot is empty, or the destination slot is full, selecting EJECT SLOT will cause a blinking RESELECT to appear on the LCD. The blinking RESELECT indicates that you attempted to select an invalid mode.

- To access **Mode 3**, press the **MODE** button until the LCD appears as shown:

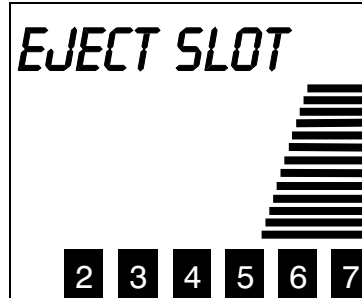

- Press the **SELECT** button to select **Mode 3**. The LCD will appear as shown (N is either 6 or 7):

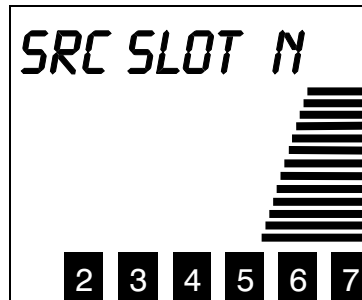

- Press the **NEXT** or **PREVIOUS** button to scroll to choose slot 6 or 7 to eject.
- Press select when the slot you wish to eject is displayed. The FastStor LTO will move the tape from the source slot to the appropriate destination slot.

Note

EJECT SLOT always moves the tape in slot 6 to slot 1, and slot 7 to slot 2.

When your FastStor LTO has completed the command, it will return to LdR REAdY.

Mode 4 – EJECT PCKR

Mode 4 causes the FastStor LTO to eject a tape left in the Media Picker to any empty destination slot.

Note

Executing EJECT PCKR Mode when the Media Picker does not have a tape will result in PCKR EMPTY and a large E (indicating an error condition) appearing on the LCD for approximately 25 seconds. If this occurs, you may press the Mode button to return the FastStor LTO to LdR REAdY before the 25 seconds elapses.

- To access **Mode 4**, press the **MODE** button until the LCD appears as shown:

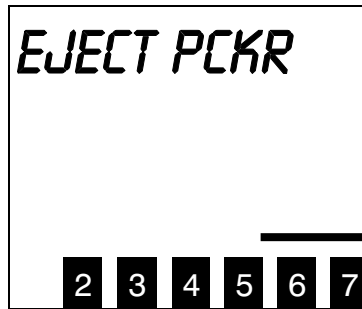

- Press the **SELECT** button to select **Mode 4**. The LCD will appear as shown while the drive ejects the tape (N is the slot the FastStor LTO will attempt to move the tape to.):

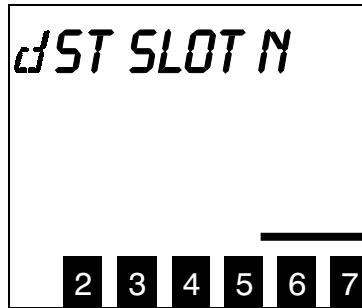

- Use the **NEXT** or **PREVIOUS** button to scroll through the destination slot choices. Press **SELECT** when the slot you wish to place the tape in is displayed. When your FastStor LTO has completed the command, it will return to LdR REAdY.

Note

If the destination slot is full, a blinking RESELECT will appear on the LCD. The blinking RESELECT indicates that you attempted to select an invalid destination slot.

Mode 6 – SET SCSI ID

Note

SCSI ID changes are not effective until power is cycled on the FastStor LTO.

Use **Mode 6** to set the SCSI ID of the FastStor LTO robotics and/or the drive.

-
- ❑ To access **Mode 6**, press the **MODE** button repeatedly until the LCD appears as shown:

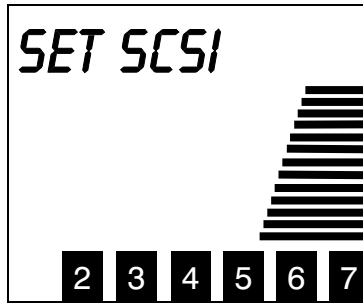

- ❑ Press the **SELECT** button to select **Mode 6**. The LCD will appear as shown:

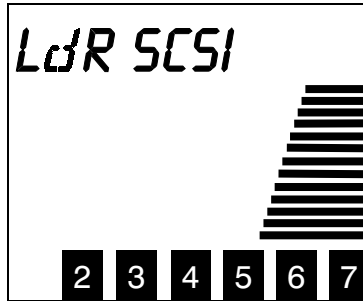

- ❑ Press **SELECT** to choose the FastStor LTO robotics. The LCD will appear as shown (X is the current ID of the robotics.):

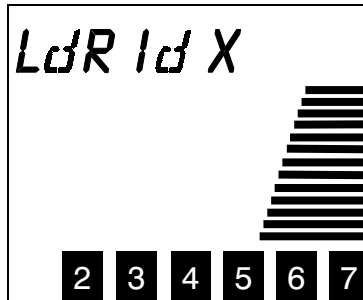

- ❑ Press **NEXT** or **PREVIOUS** button to scroll through the ID choices. Press **SELECT** when the desired ID is displayed. The LCD will appear as shown:

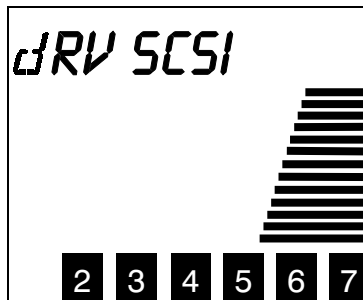

- ❑ Press **SELECT** to choose the drive. The LCD will appear as shown (X is the current SCSI ID of the drive.):

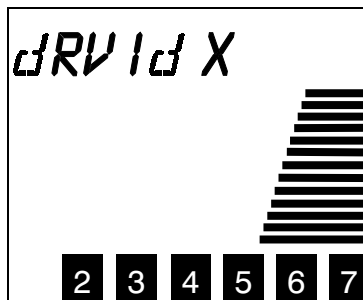

-
- Press the **NEXT** or **PREVIOUS** button to scroll through the ID choices. Press **SELECT** when the desired ID is displayed. The LCD will appear as shown below. The **CYCLE PWR** message will blink for approximately 10 seconds and then the FastStor LTO will return to LdR REAdY.

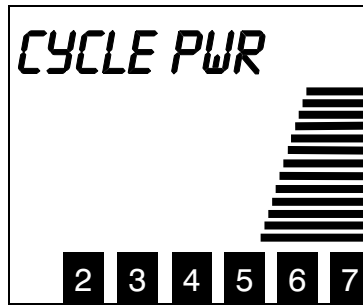

- Press and hold the **POWER** button for approximately 2 seconds to power down the FastStor LTO, then wait two or three seconds and press the **POWER** button again. The new SCSI ID will now be in effect.

Normal Maintenance

Cleaning the Drive Head

Keeping a drive clean is the single most important requirement for achieving and maintaining superior performance. Cleaning the head should always be performed as the first step if the **CT** field appears on the LCD. It is recommended that the tape head be cleaned only when the **CT** field appears on the Operator's Panel LCD. Periodic cleaning at regular intervals should not be required.

Some application packages feature an auto clean cycle. If your application supports an auto clean function, ADIC strongly recommends that you use it.

Note

ADIC recommends that you use the built-in AUTOCLEAN feature if your application does not support an auto clean cycle. However, the tape capacity of the FastStor LTO is reduced to 6 tapes whenever AUTOCLEAN is enabled.

Cleaning Tape

Use an LTO cleaning cartridge to clean the drive heads.

The cleaning cartridge is valid for 50 cleanings. Replace the cleaning cartridge when it is exhausted.

Cleaning the head should always be performed as the first step if the **CT** field appears on the LCD.

The following table tells you when to use the cleaning tape:

If . . .	It means . . .	You should . . .
1. The CT field appears on the Operator's Panel LCD	The drive head needs cleaning or the tape is bad	Use the cleaning tape to clean the drive head. When cleaning is complete, log the cleaning onto the label.
2. A data cartridge causes the CT field to appear on the Operator's Panel LCD	The data cartridge may be damaged	Back up the data from this cartridge onto another cartridge, it may be damaged. A damaged cartridge may cause unnecessary use of the cleaning cartridge.
3. The CT field re-appears after performing a cleaning and reloading the data cartridge.	Cleaning was not accomplished because the cleaning tape has exhausted all cleaning cycles. OR The data cartridge may be damaged	Replace the cleaning cartridge. Back up the data from this cartridge onto another cartridge, it may be damaged. A damaged cartridge may cause unnecessary use of the cleaning cartridge.

Drive Head Cleaning Procedure

The following procedure is to be used only if your application does not support an auto clean cycle and you choose not to use the AUTOCLEAN feature (refer to Chapter 4 for a detailed description of the AUTOCLEAN feature), or the CLEAN dRV function under the DIAGNOSTICS MENU (refer to Chapter 4 for a detailed description of the CLEAN dRV function).

Manually Cleaning the Drive Head

Notes

- To initiate the cleaning cycle manually you must be aware of the present state of the FastStor LTO and the drive that you wish to clean. The drive and storage slot 2 must be empty.
- If a cartridge is present in the drive, you must first use the Mode 1B - EJECT dRV operation to remove the cartridge. If necessary, manually remove the data cartridge from slot 2. You can then proceed with these instructions.

Caution

Cleaning cartridges are considerably more abrasive to the drive's recording head than standard data cartridges. Usage should be kept within the recommended limits.

- Open the front door of the FastStor LTO.
- Insert the cleaning cartridge into an empty storage slot.
- Use Mode 1A – LOAd dRV to load the cleaning tape into the drive.

The cleaning cycle will be performed. When cleaning is completed, perform the following instructions:

- Use Mode 1B – EJECT dRV to unload the cleaning tape from the drive and place it back in the storage slot.
- Remove the cleaning cartridge and check a usage box on the label.
- To resume normal operation, close the door and lock it.

Cleaning the Enclosure

The outside of the enclosure can be cleaned with a damp towel. If you use a liquid all-purpose cleaner, apply it to the towel. Do not directly spray the enclosure.

Chapter 4

Troubleshooting and Diagnostics

This Chapter ...

- contains some general suggestions to aid you in solving problems – should you ever run into them.
- includes information on error codes and the built-in diagnostics.

Installation Problems

Usually, problems encountered during the installation of your FastStor LTO are caused by improper SCSI bus configuration, application software configuration errors or by an OS that has not been correctly configured. If the application software that you are attempting to use is not communicating with your library after installation, check the following:

- ✓ **SCSI IDs:** Make sure that the IDs you selected for the FastStor LTO robotics and tape drive are not the same as the ID used by any other SCSI device on that bus, including the host SCSI adapter card.
- ✓ **SCSI Cabling:** Verify that all SCSI cables are securely connected at both ends and that the jackscrews are secured. Also, check the length and integrity of your SCSI cabling. The total length of a LVD/SE Ultra-2 SCSI bus must not exceed 12 meters (39.4 feet) for LVD/SE configurations (when all devices connected to the bus support the LVD mode). For an HVD Ultra SCSI bus, total bus length must not exceed 25m (82 feet.) This includes the length of all cables connected to the bus. The length of the internal SCSI cabling inside your FastStor LTO is 1 foot. This length must be included in any calculations of cable length. Try replacing suspected cables with known good cables.
- ✓ **Termination:** Check that all SCSI buses are properly terminated.
- ✓ **Compatibility:** Ensure that your FastStor LTO and its tape drive are compatible with the SCSI adapter card and application software you plan to use.

Note

For a list of compatible SCSI adapters and application software, check with your application software vendor.

- ✓ **SCSI Adapter Card Installation:** Verify that you have installed your SCSI adapter card correctly. Refer to the documentation that came with your card for installation and troubleshooting instructions. Pay particular attention to any steps describing the settings of various jumpers and/or switches on the card. Check that the card is seated fully in your computer's I/O connector.
- ✓ **Application Software Installation:** Refer to the documentation included with your software for instructions on how to verify installation.

Loader and Drive Operational Problems

Many problems with the operation of your FastStor LTO and/or LTO drive occur when the drive is not cleaned on request or when you use incorrect data cartridges. If you have been successfully operating the application software and the FastStor LTO in the past, but are now experiencing problems reading and writing data, check the following:

- ✓ If you are writing data, make sure that the cartridge is write enabled (move the write-protect switch to the enabled position).
- ✓ If the cartridge has been in use for a long time or if it has been used frequently, try using a new cartridge.
- ✓ Check the data cartridge you are using to confirm compatibility with your drive model.

DIAGNOSTIC MENU

In this section we discuss each of the diagnostic functions available through the Operator's Panel keypad.

Note

The FastStor LTO will automatically exit the **diag MENU** and return to **LdR REAdY** if the keypad is idle for 2.5 minutes.

The **DIAGNOSTIC MENU** is accessed by pressing and holding first the **NEXT** button and then the **MODE** button concurrently for approximately 5 seconds. The LCD will appear as shown:

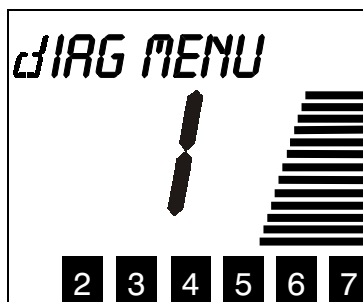

The following functions are available under the **diag MENU**:

dSP FW	When executed, this function displays the revision of the operating firmware used by FastStor LTO microprocessors and the drive.
SIGN ON	Use this function if your application software does not support ADIC FastStor, but does support ADIC FastStor DLT.
CHG MOde	Use this function to change the Mode of Operation from/to RANDOM or SEQUENTIAL .
CYCLE TEST	This function allows you to verify the functionality of the FastStor LTO robotics. CYCLE TEST exercises the FastStor LTO robotics by executing a sequence of pick and place operations, moving the cartridges between the slots and the drive.
CLEAN dRV	The CLEAN DRV function permits you to clean the drive head manually. Use this function if your application software does not support an auto cleaning cycle, and you do not want to dedicate slot 7 to the FastStor LTO AUTOCLEAN feature.
AUTOCLEAN	AUTOCLEAN provides an automatic cleaning cycle. Use AUTOCLEAN only if your application software does not support an auto cleaning cycle. Slot 7 is dedicated to the cleaning cartridge whenever AUTOCLEAN is enabled, reducing the FastStor LTO data capacity to 6 tapes.
UPG LdR F/W	When executed, this function allows you to upgrade the FastStor LTO formware via the SCSI bus, or using a field microcode replacement (FMR) tape.
dSP COUNTS	FastStor LTO keeps track of how many times certain events have occurred. The dSP COUNTS function returns these numbers to the display.
UPG dRV FW	This function allows you to upgrade the drive firmware using a field microcode replacement (FMR) tape.
DRV MAINT	This function allows you to select from several sub-functions that will cause the FastStor LTO to verify the functionality of the drive electronics, tape handling mechanism, read/write head, and media.

DISPLAY FIRMWARE

- After entering the **DIAG MENU**, press the **MODE** button to access the dSP FW function. The LCD will appear as shown:

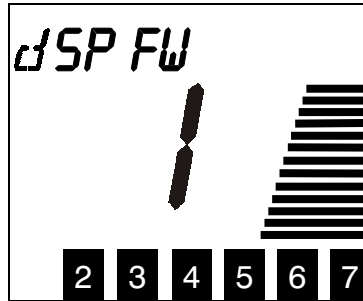

- Press the **SELECT** button to access the dSP LdR FW sub-function. The LCD will appear as shown:

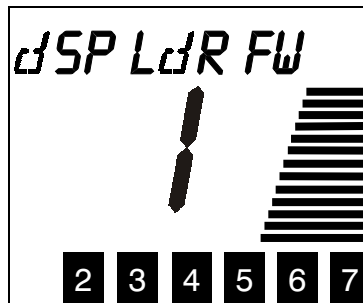

- Press the **SELECT** button to display the firmware revision for the FastStor LTO. The LCD will appear as shown (NNNN is the revision number of the firmware.):

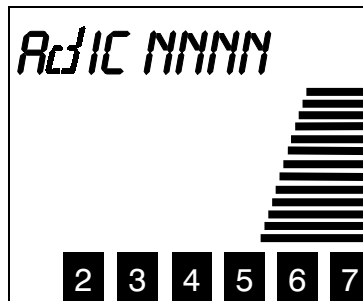

- Press **NEXT** to access the dSP dRV FW sub-function. The LCD will appear as shown:

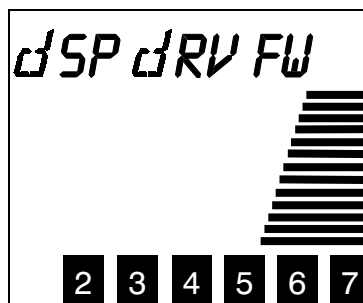

- Press the **SELECT** button to display the firmware revision for the drive. The LCD will appear as shown (NNNN is the revision number of the firmware.):

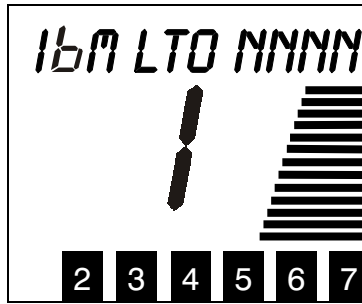

- Press **NEXT** to access the dSP MTN FW sub-function. The LCD will appear as shown:

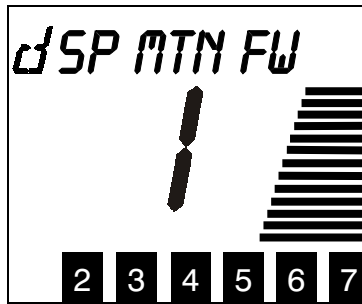

- Press the **SELECT** button to display the firmware revision for the Motion firmware. The LCD will appear as shown (NN is the revision number of the firmware.):

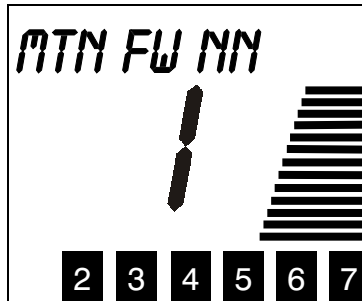

- Press **NEXT** to access the dSP FP FW sub-function. The LCD will appear as shown:

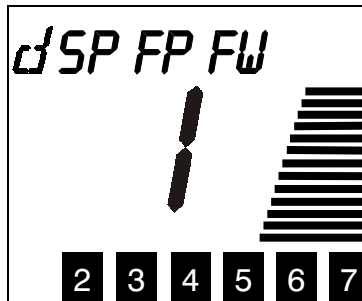

- ❑ Press the **SELECT** button to display the firmware revision for the front panel firmware. The LCD will appear as shown (NNNN is the revision number of the firmware.):

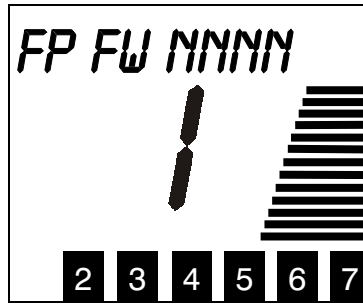

- ❑ Press **NEXT** to access the **dSP bT FW** sub-function. The LCD will appear as shown:

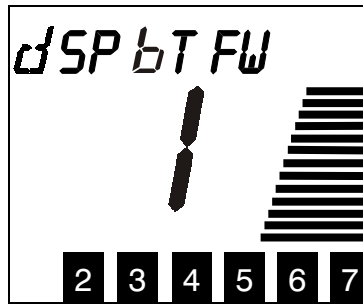

- ❑ Press **SELECT** to display the firmware revision for the boot firmware. The LCD will appear as shown (NNNN is the revision number of the firmware.):



- ❑ Press **SELECT** to return the FastStor LTO to LdR REAdY.

SIGN ON

- ❑ After entering the **DIAG MENU**, press the **MODE** button until **SIGN ON** appears on the LCD:

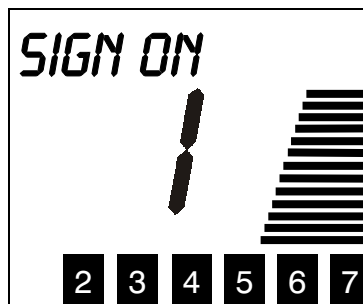

- ❑ Press the **SELECT** button to display the current sign on string.
- ❑ Press the **NEXT** or **PREVIOUS** button to toggle the sign on string between ADIC FASTSTOR and ADIC FASTSTOR DLT.
- ❑ Press the **SELECT** button to return the FastStor LTO to LdR REAdY.

CHANGE MODE

Your FastStor LTO is capable of operating in either Random-Access or Sequential-Access modes.

When in Random-Access mode, the FastStor LTO allows software selection of *any* data cartridge in *any* order. You can logically divide cartridge usage to satisfy particular data storage needs. For example, you can assign one or more cartridges to specific data functions (such as certain directories or network servers), or you can assign specific cartridges to individual users or groups (such as Sales or Engineering).

When in Sequential-Access mode, all cartridges present are considered to be a single volume. The FastStor LTO operating firmware predefines the selection of the cartridges. After initialization, the firmware will always load the first cartridge found (counting from 1 through 7) into the drive. After the application software has ejected this cartridge the FastStor LTO will automatically return the cartridge to its storage slot, and then load the next cartridge in order. Empty storage slots are ignored. It is important to note that while in Sequential-Access mode, the FastStor LTO robotics is not logically connected to the SCSI bus and does not respond to SCSI commands.

- ❑ After entering the **DIAG MENU**, press the **MODE** button until **CHG MODE** appears on the LCD:

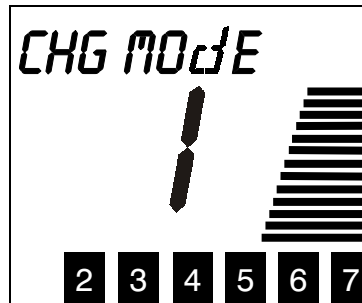

- ❑ Press the **SELECT** button to display the current mode.
- ❑ Press the **NEXT** or **PREVIOUS** button to toggle the mode between **SEQUENTIAL** and **RANDOM**.
- ❑ Press the **SELECT** button. **CYCLE PWR** will blink and appear on the LCD for approximately 10 seconds.
- ❑ Press and hold the **POWER** button for two seconds to power down the FastStor LTO.
- ❑ Wait a few seconds, then press the **POWER** button again to power up the FastStor LTO.

When in Sequential-Access mode, the FastStor LTO replaces the **LdR READy** message with a **SEQ READy** message.

If you press **MODE** when the FastStor LTO is in Sequential-Access mode, a **STOP SEQ** menu will appear on the LCD. Pressing **SELECT** while in this menu will cause a **SEQ ENDING** message to replace the **LdR READy** message and Sequential mode will finish after the currently loaded cartridge is unloaded. Pressing **MODE** after the cartridge is unloaded will cause FastStor LTO to enter the normal menu structure.

When the **SEQ ENDING** message is displayed, pressing **MODE** before the current cartridge is unloaded will cause a **RESUME SEQ** menu to be displayed. Pressing **SELECT** while in this menu will cause the previous **STOP SEQ** request to be canceled and Sequential mode will continue with the current cartridge as if **STOP SEQ** had never been requested.

When the last cartridge in the volume has been unloaded, a **SEQ dONE** message will replace the **SEQ READy** message.

When the **SEQ dONE** message is displayed, pressing **MODE** will cause a **START SEQ** menu to be displayed. Pressing **SELECT** while in this menu will cause Sequential mode to restart. Pressing **MODE** while in this menu will cause FastStor LTO to enter the normal menu structure.

CYCLE TEST

Notes

- Before executing CYCLE TEST, verify that the drive is empty. If necessary, use Mode 1B – EJECT DRIVE, to remove any cartridge from the drive.
- Before executing CYCLE TEST, verify that all seven cartridge slots have tapes installed. If required, install additional cartridges.
- If AUTOCLEAN is enabled and a cleaning tape is in slot 7, CYCLE TEST will not use slot 7 during the test.

- After entering the DIAG MENU, press the **MODE** button until CYCLE TEST appears on the LCD:

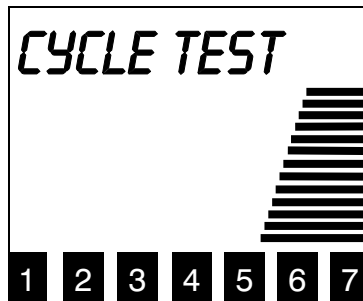

- Press **SELECT** to initiate the CYCLE TEST function. The following will appear on the LCD:

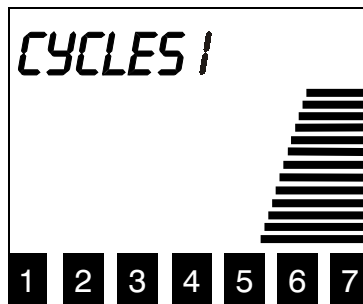

- Press the **NEXT** button to cycle through the number of desired cycles.
- Press **SELECT** when the desired number of cycle tests is displayed.

Notes

- If you want the FastStor LTO to execute CYCLE TEST continually, press PREVIOUS until CYCLES 0 is displayed.
- Press SELECT to execute continuous CYCLE TEST.
- To terminate continuous CYCLE TEST, press and hold MODE for approximately 10 seconds.

During CYCLE TEST execution, FastStor LTO moves the cartridges from one slot to another, and places each cartridge into the drive

- When CYCLE TEST is completed, your FastStor LTO will return to LdR READy.

CLEAN DRIVE

The following procedure is to be used only if your application does not support an auto clean cycle and you choose not to use the FastStor LTO **AUTOCLEAN** feature.

- After entering the **DIAG MENU**, press the **MODE** button until **CLEAN dRV** appears on the LCD:



- Press the **SELECT** button to begin the drive head cleaning process. The LCD will display the following blinking message:



- If necessary, place a cleaning tape in slot 2 then press **SELECT**. FastStor LTO will move the cleaning tape to the drive and cleaning will begin. During cleaning the following message will be displayed on the LCD, and the Activity Bars will indicate the drive activity.

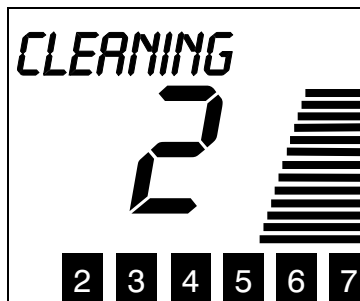

Notes

- If you press **SELECT** before placing the cleaning cartridge in slot 2, FastStor LTO will continue to display the above message.
- If a data cartridge is in slot 2 and you press **SELECT**, FastStor LTO will treat it like a cleaning cartridge and move it to the drive.
- If a cartridge is in the drive when you press **SELECT**, a **dRIVE FULL** error will be posted. Clear the error by pressing the **MODE** button. Use the **EJECT dRV** mode to remove the cartridge from the drive, then start the cleaning process again.

When the cleaning process is complete, the drive will automatically eject the cartridge, and FastStor LTO will place it back in slot 2. The following blinking message will then be displayed on the LCD:



RMV SLOT 2

- Remove the cleaning cartridge from slot 2, then press the **SELECT** button to return FastStor LTO to LdR REAdY.

AUTOCLEAN

The AUTOCLEAN function is for use with application software that does not support automated cleaning of the drive head. Applications that support automated cleaning manage tape location and use, including that of the cleaning cartridge. Do not use the AUTOCLEAN function if your application software supports automated cleaning cycles.

Enabling AUTOCLEAN

Note

The default condition is AUTOCLEAN Off.

- After entering the DIAG MENU, press the **MODE** button until AUTOCLEAN appears on the LCD:



AUTOCLEAN

- Press the **SELECT** button to access the AUTOCLEAN function. The following message will be displayed on the LCD:



SET AC ON

- ❑ Press the **SELECT** button to enable the AUTOCLEAN function. The following blinking message will be displayed on the LCD:

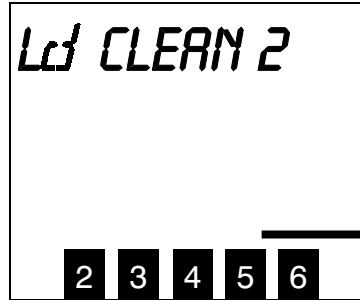

- ❑ Place the cleaning cartridge in slot 2, then press **SELECT**. FastStor LTO will move the cartridge from slot 2 to slot 7.

Notes

- If, when you press **SELECT**, slot 7 is full, FastStor LTO will return a *dEST FULL* error message and AUTOCLEAN will not be enabled. In this instance, use the **UNLOAD SLOT** mode to empty slot 7 first, then enable AUTOCLEAN.
- If you wish to abort while enabling the AUTOCLEAN function, before placing the cleaning cartridge in slot 2 and pressing **SELECT**, press the **MODE** button. FastStor LTO will return to *LdR REAdY* and AUTOCLEAN will not be enabled.
- If you do not place the cleaning cartridge in slot 2 and press **SELECT** within 2.5 minutes, the function will timeout, FastStor LTO will return to the *LdR REAdY*, and AUTOCLEAN will not be enabled.
- The Autoclean function is disabled until FastStor LTO places the cleaning cartridge in slot 7. If power is cycled prior to FastStor LTO placing the cartridge, AUTOCLEAN will remain disabled.
- If a data cartridge is in slot 2 and you press **SELECT**, FastStor LTO will treat it like a cleaning cartridge and move it to slot 7.
- If a cartridge is in the drive when you place the cleaning cartridge in slot 2 and press **SELECT**, a *dRIVE FULL* error will be posted and AUTOCLEAN will remain disabled. This is also true if the Picker is full when you press **SELECT**. In either case, clear the error by pressing the **MODE** button. The use the **EJECT dRV** mode to remove the cartridge from the drive, or the **EJECT PCKR** mode to remove the cartridge from the Media Picker, before again attempting to enable AUTOCLEAN.

Using AUTOCLEAN

AUTOCLEAN will automatically perform a cleaning whenever the drive issues a Cleaning Requested status. After completion of the head cleaning, FastStor LTO will return the cleaning cartridge to slot 7.

Notes

- When AUTOCLEAN is enabled, the application does not have access to slot 7, and FastStor LTO appears as a 6 slot loader. This forces the application to remap the FastStor LTO. Although slot 7 is unavailable to the application, the slot 7 indicator on the Operator Panel LCD functions normally (shows the presence of a cartridge when cleaning is not being performed).
- When AUTOCLEAN is enabled you still have normal access to slot 7 from the front panel, allowing you to recover from the error if the cleaning cartridge gets stuck in the Media Picker.
- If the cleaning cartridge is ever in any slot other than 7, AUTOCLEAN will not function.

If, during the cleaning, the drive issues a cleaning tape expired condition, FastStor LTO will display the following blinking message on the LCD:

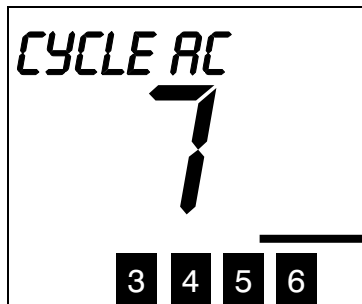

- ❑ To clear the error condition, press the **MODE** button. Now use the front panel to replace the cleaning cartridge with a new one. This will allow Autoclean to remain on. If desired, follow the instructions in the following section to first disable AUTOCLEAN, then re-enable it using a new cleaning cartridge.

Disabling AUTOCLEAN

- ❑ After entering the DIAG MENU, press the **MODE** button until AUTOCLEAN appears on the LCD:

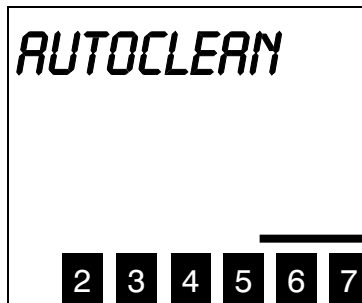

- ❑ Press the **SELECT** button to access the AUTOCLEAN function. The following message will be displayed on the LCD:



-
- ❑ Press the **SELECT** button to disable the **AUROCLEAN** function. FastStor LTO will move the cleaning cartridge from slot 7 to slot 2. The following blinking message will be displayed on the LCD:

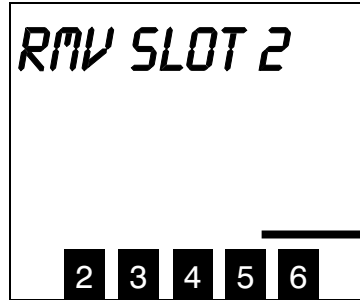

- ❑ Remove the cleaning cartridge from slot 2, then press **SELECT**. FastStor LTO will return to LdR REAdY.

Notes

- If a cartridge is present in slot 2, FastStor LTO will post a dEST FULL error and AUROCLEAN will remain on.
- The AUROCLEAN function remains enabled until FastStor LTO places the cleaning cartridge in slot 2. If power is cycled after the Media Picker picks the cartridge, but prior to FastStor LTO placing the cartridge in slot 2, AUROCLEAN will remain enabled. In this instance, when power is returned, use the EJECT PCKR Mode to place the cleaning cartridge in slot 7, then attempt to disable AUROCLEAN again.

UPGRADE LOADER FIRMWARE

Whenever new firmware for the FastStor LTO is released, complete instructions on how to use the UPG LdR FW function to perform the upgrade via the SCSI bus will be included on the firmware diskette. You may also use the UPG LdR FW function to perform the upgrade using a field microcode replacement (FMR) tape. Perform the following instructions to upgrade the FastStor loader firmware using an ADIC-provided FMR tape.

- ❑ After entering the DIAG MENU, press the **MODE** button until UPG LdR FW appears on the LCD:

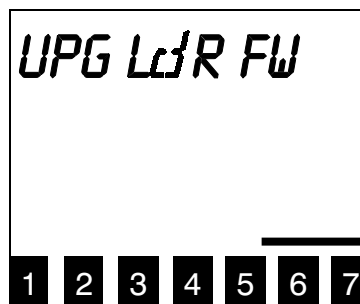

-
- Press **SELECT** to choose the loader firmware upgrade function. The following message will be displayed on the LCD:

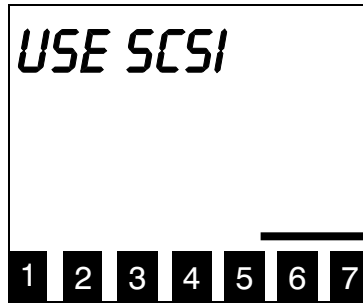

- Press **NEXT** or **PREVIOUS** to display the USE FMR option. The following will appear on the LCD:

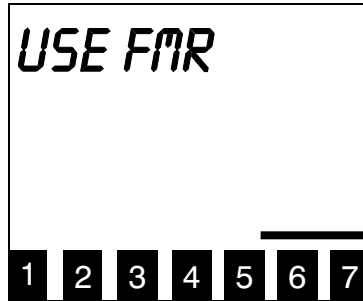

- Press **SELECT** to begin the loader firmware upgrade process. The following message will be blinking on the LCD:

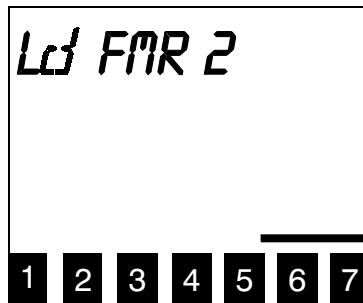

- If not already installed, place the loader FMR tape in slot 2 then press **SELECT**. If you press **SELECT** before placing the FMR tape in slot 2, **UPG dRV FW** will appear momentarily on the LCD and then the following blinking message will appear.

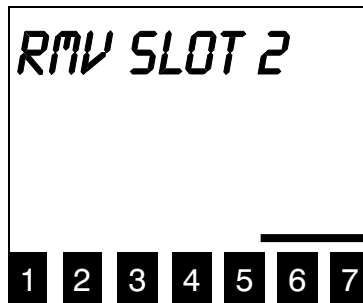

-
- ❑ In this instance, remove the cartridge from slot 2 and replace it with the loader FMR tape. The following will appear on the LCD:

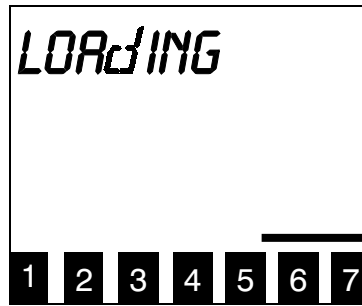

as the FMR tape is loaded, and then the following will appear on the LCD as the drive upgrades the loader firmware:



When the update process is completed, the FastStor LTO will auto-unload the tape and return it to slot 2. The following message will be blinking on the LCD:

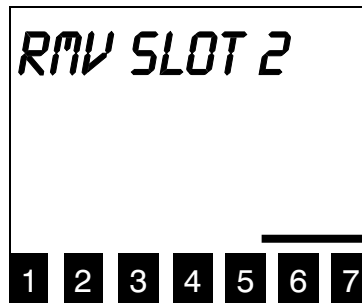

- ❑ Remove the FMR tape from slot 2, then press **SELECT** to return the FastStor LTO to LdR REAdY.
- ❑ Verify that the firmware upgrade was successful by using the DSP FW function of the DIAG MENU to display the revision number of the current operating firmware.

DISPLAY COUNTS

- ❑ After entering the DIAG MENU, press the **MODE** button until dSP COUNTS appears on the LCD:

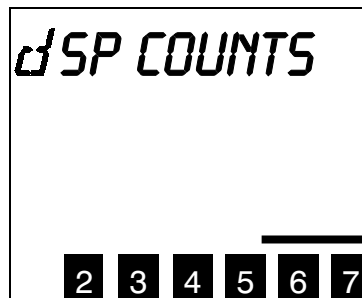

- Press the **SELECT** button to access the first event. The display will appear as shown:

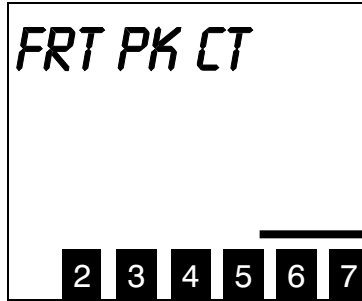

- Press **SELECT** again to return the number of times that FastStor LTO has picked a cartridge from any of the front slots. The display will appear similar to the following:

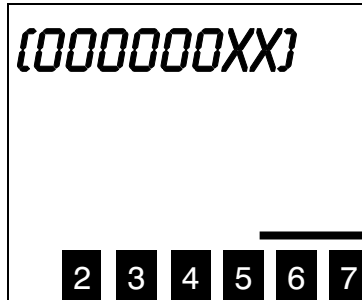

- Press **NEXT** to access the next event.

The events that FastStor LTO keeps track of are listed below:

- Front Pick Cartridge
- Front Pick Retries
- Rear Pick Cartridge
- Rear Pick Retries
- Drive Pick Cartridge
- Drive Pick Retries
- Front Place Cartridge
- Front Place Retries
- Rear Place Cartridge
- Rear Place Retries
- Drive Place Cartridge
- Drive Place Retries
- Drive Door Retries

- Pressing **SELECT** when the return value for dRV dR RE is displayed will return FastStor LTO to LdR REAdY. Also, pressing the **MODE** button at any time will return FastStor LTO to LdR REAdY.

UPGRADE DRIVE FIRMWARE

The following procedure is to be used only when you are upgrading the drive firmware from a field microcode replacement (FMR) tape.

- After entering the dIAG MENU, press the **MODE** button until the following appears on the LCD:



- ❑ Press **SELECT** to begin the drive firmware upgrade process. The following message will be blinking on the LCD:

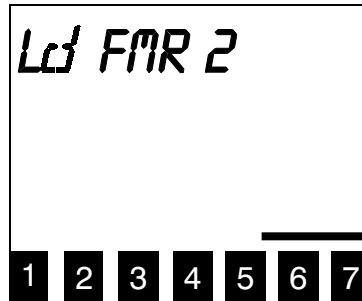

- ❑ If not already installed, place a FMR tape in slot 2 then press **SELECT**. If you press **SELECT** before placing the FMR tape in slot 2, **UPG dRV FW** will appear momentarily on the LCD and then the blinking **CT 2 (SEL)** message will reappear.

The drive will be placed in a “prepare for firmware upgrade via tape” mode. The FastStor LTO will move the FMR tape to the drive and the upgrade process will begin. **UPdATING** will appear on the LCD, the three front panel LEDs will alternate between **POWER** on, **ACTIVITY** off, **ALARM** on, **POWER** off, **ACTIVITY** on, **ALARM** off, and the Activity Bars will indicate the drive activity; also, the **POWER** button will be disabled during the upgrade.

When the update process is completed, the FastStor LTO will auto-unload the tape and return it to slot 2. The following message will be blinking on the LCD:

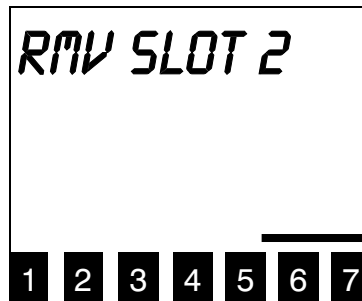

- ❑ Remove the FMR tape from slot 2, then press **SELECT** to return the FastStor LTO to LdR REAdY.

If the **dRIVE PGRM** message and the error indicator **E** appear on the LCD after several minutes, perform the following:

- ❑ Verify that the tape is a valid FMR tape and not a data or cleaning cartridge.
- ❑ If you believe that the tape is OK, repeat the update process. If the FastStor LTO displays the same error message, call ATAC for assistance.

DRV MAINT

- ❑ After entering the DIAG MENU, press and hold the **MODE** button until DRV MAINT appears on the LCD.
- ❑ Press the **SELECT** button to access the DRV MAINT sub-functions. DRV DIAGS will be displayed on the LCD.
- ❑ Press the **SELECT** button to select the DRV DIAGS function, or press the **NEXT** button repeatedly until the sub-function you desire is displayed on the LCD. A brief description of the sub-functions available are listed below:

DRV DIAGS	Also known as the Read/Write Test, DRV DIAGS includes several tests that ensure the drive can read from and write to tape. This sub-function takes approximately four minutes to complete.
DSPLY ERLG	This sub-function will display the last 10 drive error codes, one at a time (the codes are ordered; most recent is presented first and oldest is presented last), on line 1 of the display.
CLR ERRLOG	This sub-function will erase the contents of the Drive Error Log
DRV DUMP	This sub-function will cause the drive to perform a dump of its microcode (save a microcode trace).
DUMPTOTAPE	This sub-function causes the drive to copy the data from the latest drive dump to the beginning of a scratch tape.

DRV DIAGS

- ❑ Pressing **SELECT** when DRV DIAGS is displayed will cause the drive to execute the Read/Write Test diagnostics. The following will be blinking on the LCD.

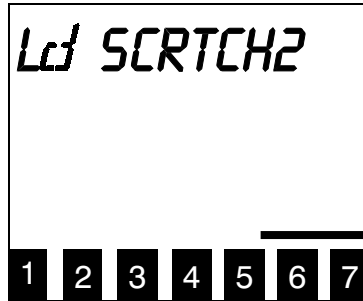

- ❑ Place a write-enabled scratch tape in slot 2. If slot 2 is not empty, the following will be blinking on the LCD:

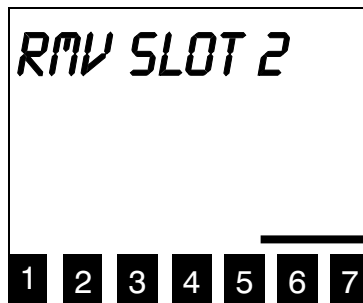

- ❑ In this instance, remove the cartridge from slot 2 and replace it with the scratch tape.
- ❑ Press **SELECT**. The following will appear briefly on the LCD:

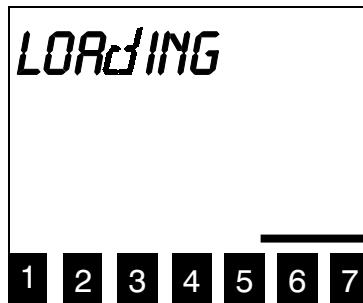

as the scratch tape is loaded, then a series of messages will appear on the LCD as the drive executes the test.

- ❑ When the test is finished, and if no errors were encountered, the following will appear on the LCD:

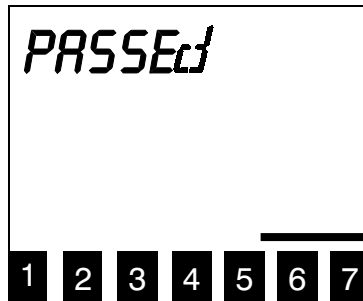

Press the **SELECT** button to unload the scratch cartridge. The following will be blinking on the LCD:

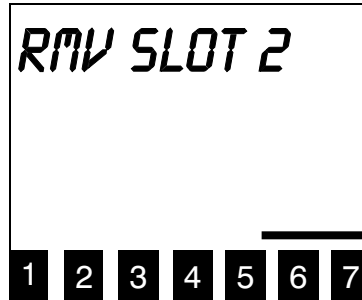

- Remove the scratch tape from slot 2.
- Press **SELECT** to return to DRV DIAGS.

If the test fails, an appropriate drive error code will appear on the LCD. Refer to the Drive Error Code table later in this chapter for a detailed description of the drive error codes.

DSPLY ERLG

- After entering the DIAG MENU, press and hold the **MODE** button until DRV MAINT appears on the LCD.
- Press the **SELECT** button to access the DRV MAINT sub-functions. **DRV DIAGS** will be displayed on the LCD.
- Press the **NEXT** button repeatedly until the following appears on the LCD:



- Press the **SELECT** button to display the first of the ten most recent error codes on the LCD, beginning with the most recent. If there are no errors or less than 10 available, zeros will appear as space holders. A message similar to the following will appear on the LCD:

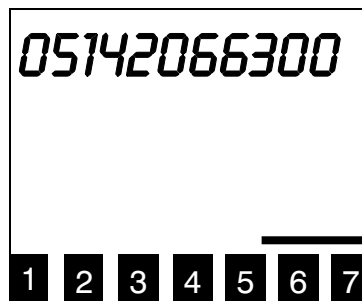

The first character represents the order of the error code in this sequence. The errors are numbered sequentially from 0 to 9, with 0 the most recent and 9 the oldest. The second character is the actual code that appeared on the LCD when the error occurred. If there are no errors in the log, 0 appears. The remaining eight characters may be ignored.

- Press **NEXT** to cycle through all 10 errors.
- Press **SELECT** to return to DSPLY ERLG.

CLR ERRLOG

- After entering the DIAG MENU, press and hold the **MODE** button until DRV MAINT appears on the LCD.
- Press the **SELECT** button to access the DRV MAINT sub-functions. DRV DIAGS will be displayed on the LCD.
- Press the **NEXT** button repeatedly until the following appears on the LCD:

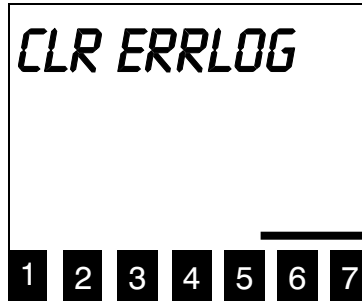

- Press the **SELECT** button to clear the drive error log.
- When the drive error log is cleared, and if no errors were encountered, the following will appear on the LCD:

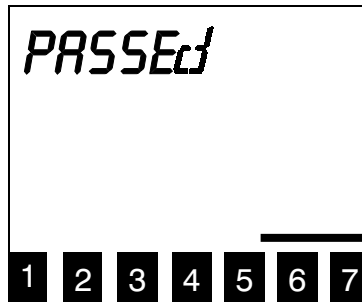

- Press **SELECT** to return to CLR ERRLOG.

DRV DUMP

- After entering the DIAG MENU, press and hold the **MODE** button until DRV MAINT appears on the LCD.
- Press the **SELECT** button to access the DRV MAINT sub-functions. DRV DIAGS will be displayed on the LCD.
- Press the **NEXT** button repeatedly until the following appears on the LCD:

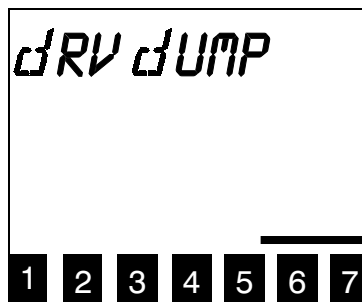

- Press the **SELECT** button to have the drive perform a dump of data collected by the drive (save a microcode trace).

- ❑ When the dump is completed, and if no errors were encountered, the following will appear on the LCD:

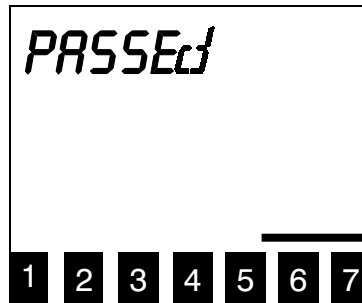

- ❑ Press **SELECT** to return to DRV DUMP.

DUMPTOTAPE

- ❑ After entering the DIAG MENU, press and hold the **MODE** button until DRV MAINT appears on the LCD.
- ❑ Press the **SELECT** button to access the DRV MAINT sub-functions. DRV DIAGS will be displayed on the LCD.
- ❑ Press the **NEXT** button repeatedly until the following appears on the LCD:

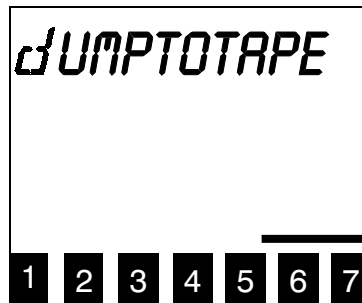

- ❑ Press **SELECT**. The following will be blinking on the LCD:

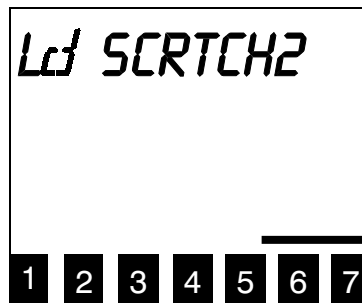

- ❑ Place a write-enabled scratch tape in slot 2. If slot 2 is not empty, the following will be blinking on the LCD:

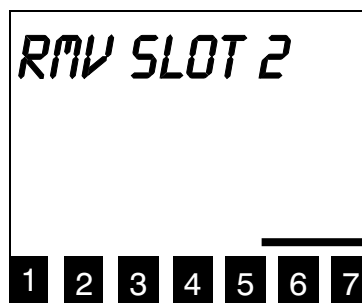

- ❑ In this instance, remove the cartridge from slot 2 and replace it with the scratch tape.
- ❑ Press **SELECT**. The following will appear briefly on the LCD:

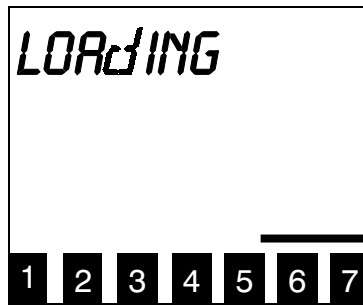

as the scratch tape is loaded, then a series of messages will appear on the LCD as the drive copies the dump to the cartridge.

When the drive is finished writing to the cartridge, the following will appear on the LCD:

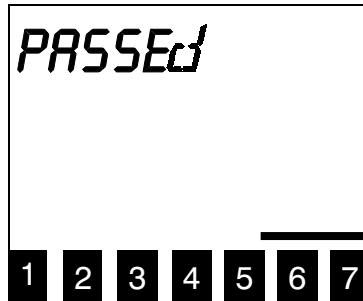

Press the **SELECT** button to unload the scratch cartridge. The following will be blinking on the LCD:

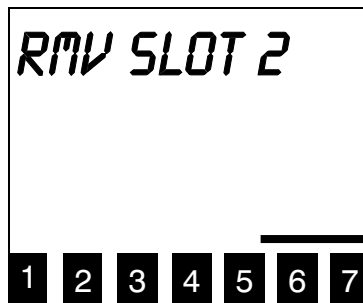

- Remove the scratch tape from slot 2.
- Press **SELECT** to return to DUMPTOTAPE.

If the DUMPTOTAPE function fails, an appropriate drive error code will appear on the LCD. Refer to the Drive Error Code table later in this chapter for a detailed description of the drive error codes.

DRV POST

- After entering the DIAG MENU, press and hold the **MODE** button until DRV MAINT appears on the LCD.
- Press the **SELECT** button to access the DRV MAINT sub-functions. DRV DIAGS will be displayed on the LCD.
- Press the **NEXT** button repeatedly until the following appears on the LCD:

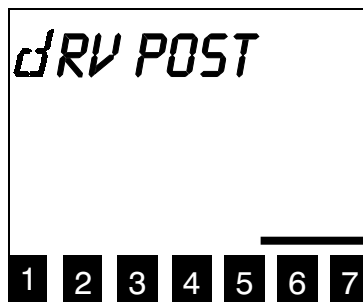

- ❑ Press the **SELECT** button to have the drive perform its Power On Self Test.

When the drive successfully finishes running its POST, the following will appear on the LCD:

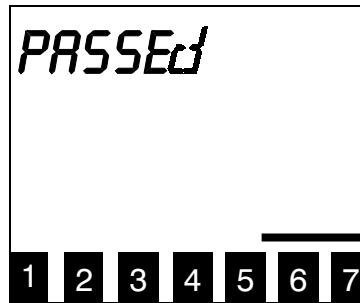

- ❑ Press **SELECT** to return to DRV POST.
- ❑ If the drive POST fails, an appropriate error message will appear. Refer to the Drive Error Code table later in this chapter for a detailed description of the drive error codes.

FastStor LTO Error Messages

If, during operation of your FastStor LTO an error occurs, the FastStor LTO will halt the current operation and an error message will be displayed on the LCD. In all cases, after removing the cause of the problem, cycle power on your FastStor LTO and try the last operation again.

Error Message Listing

A description of each of the FastStor LTO error messages is provided in the following table:

Error Name	Description	Error Name	Description
SERIAL RCV	Interprocessor communication error	PCKR EMPTY *	The media picker was empty
SRC EMPTY *	The source location is empty	SLOT FULL *	There was medium in slot
dEST FULL *	The destination location is full	NVM SELECT	NVRAM selection failure
CPU RX ERR	The motion CPU is not ready to receive	NVM WRITE	NVRAM write failure
CPU TX ERR	The motion CPU is not ready to transmit	dRIVE EJCT	Drive failed to eject medium
PWR SWITCH	The front power switch was pressed	dRIVE UNLd *	Drive not logically unloaded
HALT	The motion CPU has been halted by a low ACT line	dRIVE HNdL	Drive 'Operate Handle' timeout
CAM LIMIT	A cam limit has been reached w/o tripping a sensor	dRIVE BUSY	Drive busy, cannot unload tape
INV MOV OP *	An invalid move operation occurred	dRIVE dOOR	Drive door stepper motor limit
REAR TAPE	A rear tape sensor was not tripped	dRIVE FULL *	The drive was full
FRONT TAPE	A front tape sensor was not tripped	CT FAILED	Cleaning tape failed to clean drive
REAR SLOT	A rear slot sensor was not tripped	dRIVE POST	Drive failed its POST
FRONT SLOT	A front slot sensor was not tripped	RObOT POST	Robotics failed its POST
PCKR FULL *	The media picker was full		

* These errors will not appear on the LCD if the error occurred during SCSI interaction.

Note

During the FastStor LTO POST, if the CT FAILED, dRIVE bUSY, dRIVE dOOR, dRIVE EJECT, dRIVE HNdL, dRIVE LOAd, dRIVE PGRM, or dRIVE UNLd error occurs, dRIVE POST will appear on the Operators Panel LCD. All other errors occurring during FastStor LTO POST will result in ROBOT POST being displayed.

Drive Error Codes

If, during normal operation or while executing DRV MAINT functions, a drive error occurs, a drive error code will appear on the LCD. A description of each of the drive error codes is provided in the following table:

If the code is this...	It means this...
0	No error. This code displays: <ul style="list-style-type: none">• When power is cycled (turned off, then on) to the FastStor LTO Autoloader.• When diagnostics have finished running and no error occurred.
1	Cooling problem. The tape drive detected that it exceeded the recommended operating temperature. The error clears when the tape drive cools.
2	Power problem. The tape drive detected that the externally supplied power is approaching the specified voltage limits (the drive is still operating) or is outside the specified voltage limits (the drive is not operating).
3	Firmware problem. The tape drive determined that a firmware error occurred.
4	Firmware or tape drive problem. The tape drive determined that a firmware or tape drive hardware failure occurred.
5	Tape drive problem. The drive determined that a tape drive hardware failure occurred.
6	Tape drive or media error. The drive determined that an error occurred, but it cannot isolate the error to faulty hardware or to the tape cartridge.
7	Media error. The tape drive determined that an error occurred because of a faulty tape cartridge.
8	Tape drive or SCSI bus error. The tape drive determined that a failure occurred in the tape drive hardware or in the SCSI bus.
9	Tape drive or RS-422 error. The tape drive determined that a failure occurred in the tape drive hardware or in the RS-422 connection.
A, E, F, o, c, b, d, or h	No error or message assigned. There may be a problem with the message display.
B	No error or message assigned.
C	The tape drive needs to be cleaned.
D	No error or message assigned.

Environmental Considerations

For best performance of your FastStor LTO, and to minimize the chance of condensation, please observe the following guidelines:

- Install your FastStor LTO on a level surface. Do not place FastStor LTO on a carpeted surface.
- If you expose cartridges to temperatures outside the operating limits, 10-40°C (50-104°F), stabilize them by leaving the cartridges in the operating temperature for a minimum of two hours before you use them.
- Avoid temperature problems by ensuring that the FastStor LTO rear panel is not obstructed so that the drive has adequate ventilation.
- Position the FastStor LTO where the temperature is relatively stable (i.e., away from open windows, fan heaters, and doors).
- Avoid leaving cartridges in severe temperature conditions, for example, in a car standing in bright sunlight.
- Avoid transferring data (reading from and writing to cartridges) when the temperature is changing by more than 10°C (15°F) per hour.

When You Call ADIC'S Technical Assistance Center

Before calling ATAC, follow these steps – which will help you take full advantage of your call:

- Review all documentation carefully. (Experience has demonstrated that most questions are answered in your documentation.)
- Be prepared to explain whether the software or hardware has worked properly at anytime in the past. Have you changed anything recently?
- Pinpoint the exact location of your problem, if possible. Note the steps that led to the problem. Are you able to duplicate the same problem or is it a one-time occurrence?
- Note any error messages displayed on your PC screen or file server. Write down the exact error message.
- If at all possible, call while at your computer, with ADIC's system installed and turned on.
- If running on a network, have all relevant information available (i.e. type, version #, network hardware, etc.).
- Be prepared to provide:
 - Your name and your Company's name
 - Model number
 - Serial number of FastStor LTO (located inside the unit, under the bottom cartridge slot)
 - Serial number of drive assembly (located on rear panel, above SCSI connectors)
 - Software version numbers
 - device driver
 - archive/restore
 - Hardware configuration, including firmware version, date and number
 - Type of PC, DOS version, clock speed, RAM, network type, network version, and any special boards installed
 - A brief description of the problem
 - Where you purchased the ADIC system

Having this information available when you call for customer assistance will enable ADIC to resolve your problem in the most efficient manner possible.

Note

In the US and Canada, call ATAC at 1-800-827-3822.

In Europe, call ATAC at +800.9999.3822.

Blank Page

Appendix

A

Specifications

This Appendix ...

- contains specification information on the FastStor LTO and the LTO drive.

Drive:

Type:	IBM® Ultrium I Tape Drive
Data Capacity: (compressed mode)	Up to 200 GB with 100 GB data cartridge
Data Transfer Rate: (compressed mode)	30 MB/sec. sustained (1.8 GB/min.)

Loader:

Media type:	LTO ½-inch, metal-particle cartridges
Capacity:	Up to 1.4 TB
Cartridge Change:	10 seconds max
Indicators/Controls:	4 button keypad with LCD menu display, Power button, Power LED, Activity LED and Alarm LED to monitor and control system status, diagnostics and configuration
Interface:	FastStor LTO with Ultrium I drive — LVD Ultra-2 SCSI, 68-pin HD or HVD Ultra SCSI, 68-pin HD

Reliability:

Maintenance:	Drive head cleaning with LTO cleaning cartridge when indicated by drive, or automatic with Autoclean enabled.
MSBF:	Greater than 250,000 cartridge changes (net, drive and media) with scheduled maintenance.
MTBF:	More than 100,000 power-on hours
MTTR:	Within 30 minutes

Physical:

Dimensions:	Width = 24.1cm (9.50") Depth = 58.1cm (22.87") Height = 19.0cm (7.48")
Weight:	13.0 kg (28.7 lbs)
Shipping Weight:	16.7 kg (37 lbs)

Power Consumption:

Less than 85 Watts

Environment:

Electrical:	100-240 V~, 50-60 Hz, 1.2-0.6 Amps, Auto Voltage Select
Temperature:	10° C to 38° C (50° F -100° F) Operating
Humidity:	10% to 80% RH, non-condensing (Operating)
Vibration:	0.5 g (5-500-5 Hz), Operating Tested per ISTA for storage/shipping
Shock:	15 g Operating Impact tested per ISTA for storage/shipping

Appendix B

Conversion Instructions (for Desktop and Rackmount applications)

This Appendix ...

- contains detailed instructions on converting a desktop FastStor LTO to a rackmountable unit.
- contains detailed instructions on converting a rackmounted FastStor LTO to a desktop unit.

The FastStor was designed with the unique ability to be converted from a desktop unit to a rackmount unit. This provides you with the flexibility of using your FastStor in multiple environments. The following instructions will guide you through the easy conversion procedure. If you need technical assistance, contact ADIC.

Converting from Desktop to Rack Mount

When rack-mounting a desktop FastStor autoloader, you must remove the outer cover and bezels from the unit before it can be rackmounted.

Tools Required

- # 1 phillips screwdriver

The following instructions describe the actions you need to perform to remove the outside covers and trim bezels from your desktop FastStor.

Removing the Outer Cover

1. Using a # 1 phillips screwdriver, remove the four 4-40 x 3/8" button-head screws that secure the front and back edge of the outer cover to the FastStor chassis. The following illustration shows the location of two of these screws. The other two screws are located similarly on the left side of the chassis:

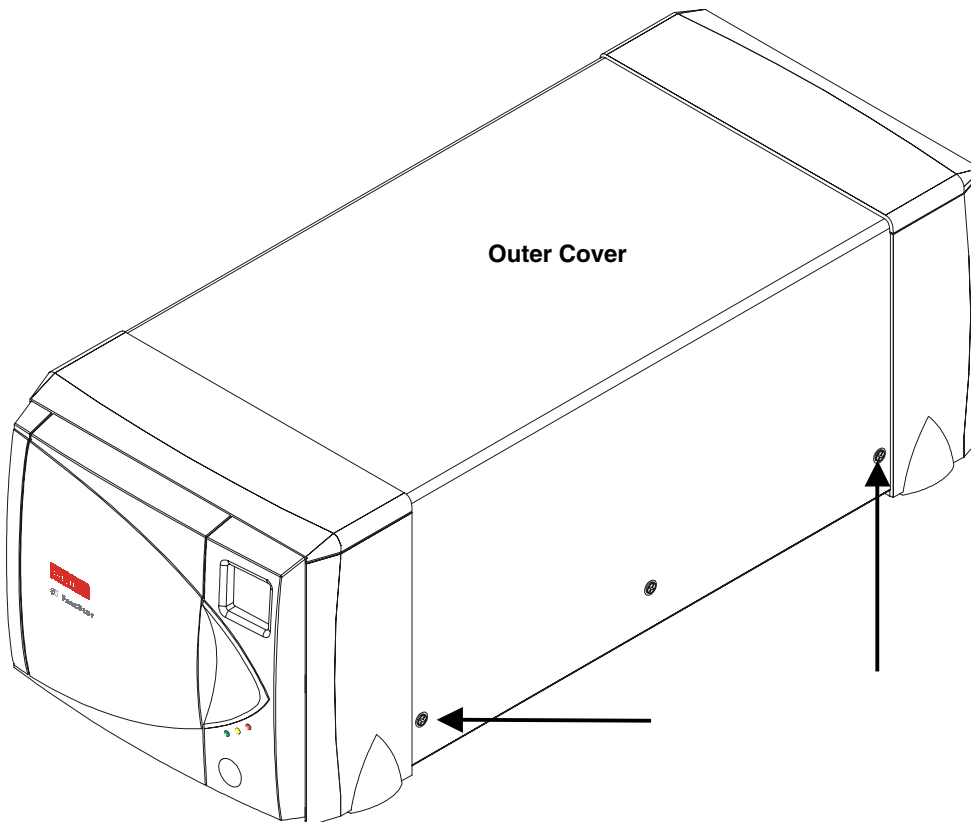

-
- Using a # 1 phillips screwdriver, loosen, but do not remove, the two 4-40 x 3/8" button-head screws that secure the middle of the outer cover to the FastStor chassis. The following illustration shows the location of one of these screws. The other screw is located similarly on the left side of the chassis:

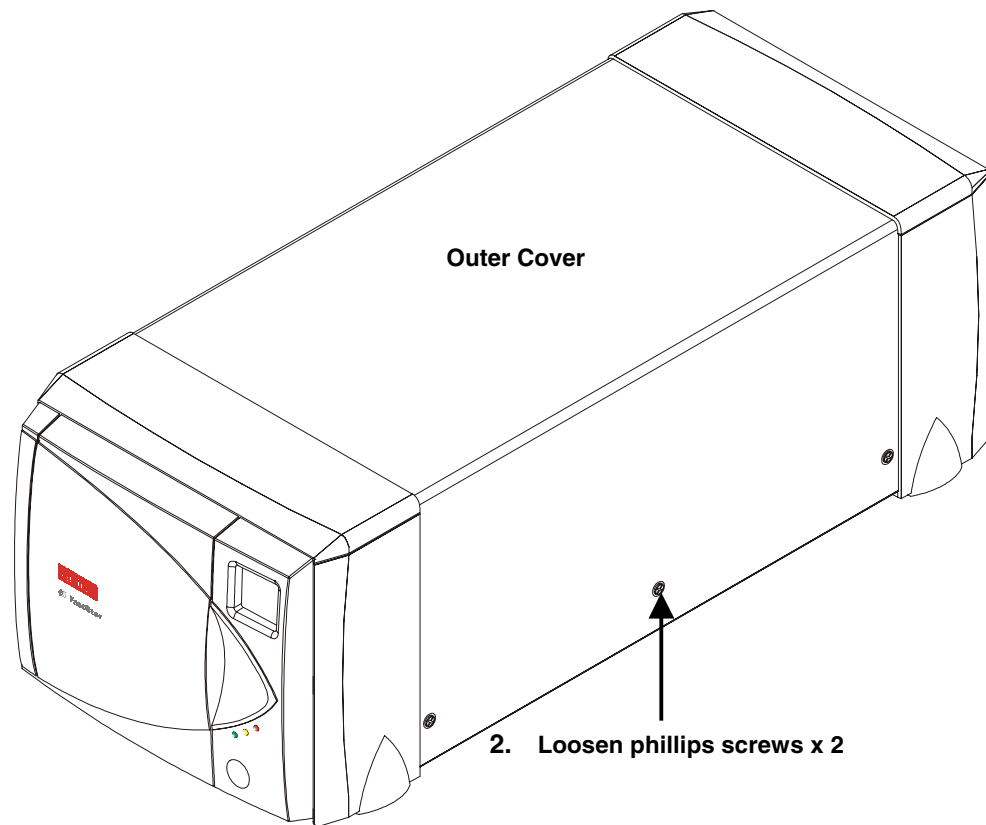

- Flex both sides of the bottom edge of the outer cover away from the chassis, then lift the outer cover up to remove it.

Removing the Trim Bezels

Each of the bezels uses one or two polymer buttons that fit into keyholes in the chassis and help secure the bezel to the FastStor. The exploded cutaway view in the illustration below shows a button inserted into a keyhole. Additionally, the top rear and side bezels are each secured to the chassis with two phillips screws. The illustration below shows the locations of the screws that secure the top rear and right side bezels. The screws that secure the left side bezels are located similarly.

When button clears slot in keyhole, lift bezel from chassis.

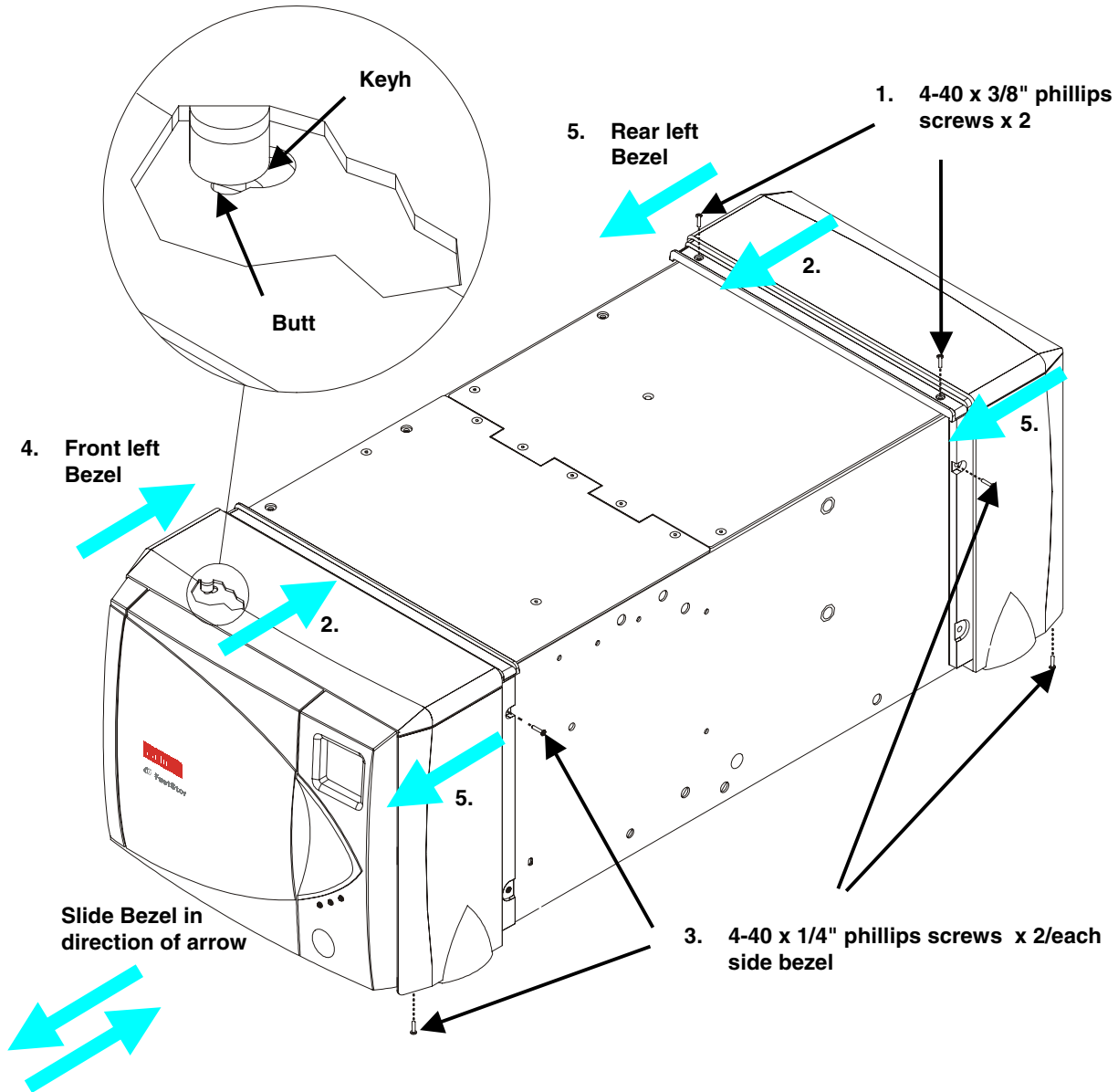

1. Using a # 1 phillips screwdriver, remove the two 4-40 x 3/8" phillips screws that secure the rear top bezel to the chassis. The illustration above shows the location of these screws.
2. Push the front top bezel rearward and the rear top bezel forward, until the buttons clear the slot in the keyhole and the bezels can be lifted away from the chassis.
3. Using a #1 phillips screwdriver, remove the two 4-40 x 1/4" phillips screws that secure each of the side bezels to the FastStor chassis. Note the screw in the bottom of each bezel.
4. Push the front left bezel rearward, until the button clears the slot in the keyhole and the bezel can be lifted away from the chassis.
5. Pull the remaining side bezels forward, until the buttons clear the slots in the keyholes and the bezels can be lifted away from the chassis.
6. Using a # 1 phillips screwdriver, remove the four rubber feet from the bottom of the FastStor chassis.

Your FastStor is now ready to be rack-mounted. Refer to your "FastStor Rackmount Installation Instructions", for detailed rack-mounting instructions.

Converting from Rackmount to Desktop

When converting a rack-mounted FastStor autoloader to a desktop unit, you must first remove the unit from the rackmount assembly. When the unit has been removed from the rack assembly, the trim bezels and outer cover can be installed.

Tools Required

- # 1 phillips screwdriver

Installing the Trim Bezels

The following instructions describe the actions you need to perform to install the trim bezels to your FastStor LTO autoloader.

Installing the Side Bezels

Each of the side bezels uses one polymer button that fits into a keyhole in the chassis and helps secure the bezel to the FastStor. Additionally, the side bezels are each secured to the chassis with two 4-40 x 1/4" phillips screws. The following illustration shows the locations of the screws that secure the right side and rear top bezels. The screws that secure the left side bezels are located similarly.

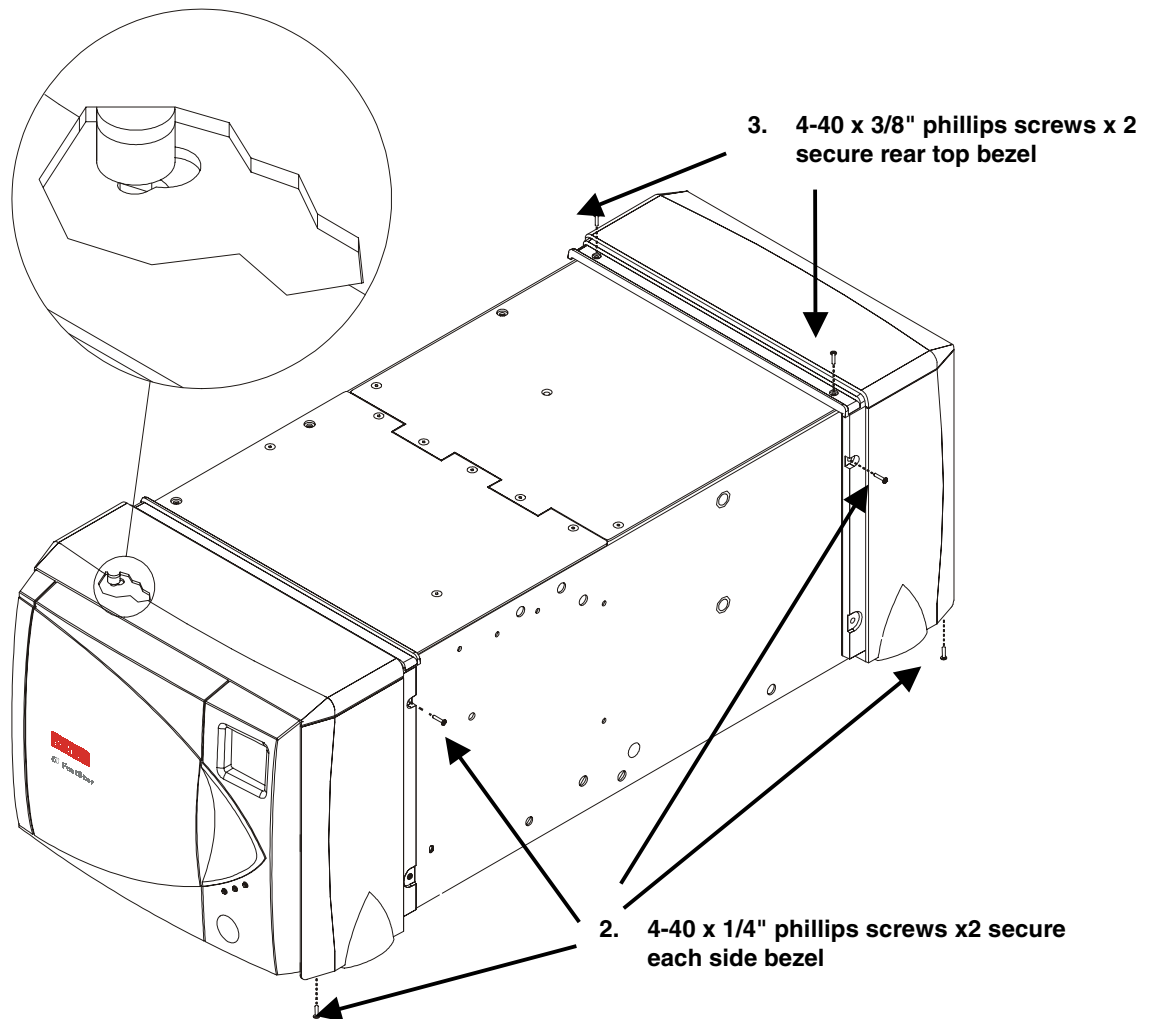

1. Insert the polymer button on the bezel into the appropriate keyhole in the chassis and move it in the correct direction to seat the button in the small end of the keyhole. Note that the left front side bezel has to be pulled forward to fit the button into the small end of its keyhole, and the three other side bezels need to be pushed rearward to seat their buttons correctly.
2. Use a # 1 phillips screwdriver to secure each side bezel to the chassis using the two 4-40 x 1/4" phillips screws provided.

Installing the Upper Bezels

3. Place the polymer buttons on each upper bezel into the appropriate keyholes in the top panels of the chassis.
4. Pull the front bezel forward and push the rear bezel backwards to seat the buttons in the small end of the keyholes.
5. Using a # 1 phillips screwdriver, secure the rear top bezel to the chassis using the two 4-40 x 3/8" phillips screws provided.

Installing the Outer Cover

1. Slide the outer cover down over the exposed ends of the trim bezels until the three holes on each side align with the holes in the chassis, and front and rear side bezels.
2. Using a # 1 phillips screwdriver, secure the middle of the outer cover to the chassis by tightening the two 4-40 x 1/4" phillips screws located in the middle holes. The illustration below shows the location of the screw on the right side of the cover. The location of the screw on the left side is similar.
3. Using a # 1 phillips screwdriver, secure the front and back edge of the cover in place with the four 4-40 x 1/4" phillips screws provided. The illustration below shows the location of the screws on the right side of the cover. The location of the screws on the left side is similar.
4. Using a # 1 phillips screwdriver, secure the four rubber feet to the bottom of the FastStor chassis.

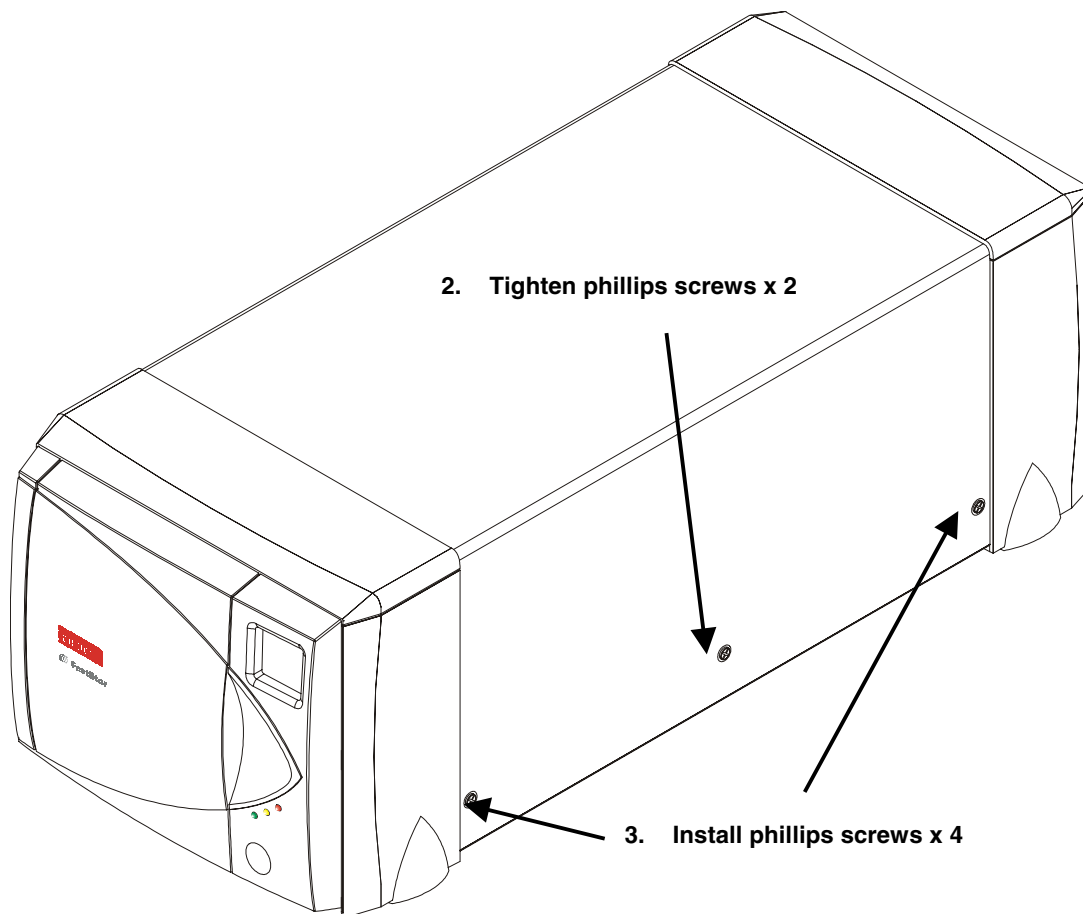

Your FastStor is now converted for desktop use.

INDEX

A

AC Power Connector, 4
Activity Bars, 5
Activity LED, 4, 5
Alarm LED, 4
application software, 3, 10, 12, 14, 30
Application Software, 7, 30
archiving, 2

B

backup operations, 14
backup software, 7
Built-in Diagnostics, 3

C

cartridge inventory, 5, 15
Cartridge Pre-Check, 3
cleaning cartridge, 3, 27
Cleaning Tape, 27
Cleaning the Drive Head, 27
Cleaning the Enclosure, 28
CLR ERRLOG sub-function, 45, 48
Copyright Notice, *ii, iii*

D

data storage software, 7
DIAG MENU, 45, 47, 48, 49, 50
diagnostic firmware, 3
diagnostic results, 3
Digital Linear Tape, 2
DLT drives, 14
drive activity, 4, 5
Drive Data Capacity, 56
Drive Data Transfer Rate, 56
drive electronics, 31
drive error codes, 45, 47, 50, 51, 52
Drive Error Log, 45
drive head cleaning, 3
drive operating status, 3
drive status, 4
Drive Type, 56
DRV DIAGS function, 50
DRV DIAGS sub-function, 45, 46, 47, 48, 49
DRV DUMP sub-function, 45, 48
DRV MAINT function, 45, 47, 48, 49, 50
DRV MAINT function, 31
DRV POST sub-function, 46
DRVPOST sub-function, 50
DSPLY ERLG sub-function, 45, 47
DUMPTOTAPE sub-function, 45, 49, 50

E

EMI/RFI Compliance, *iv*
Environmental Considerations, 53

error messages, 4, 5
Exabyte Emulation, 3

F

formatted capacity, 2

H

Head Cleaning Procedure, 27
hierarchical storage management, 2
host adapter, 10, 11
host computer, 7, 10, 11, 12, 14, 18
HSM, 2

I

I/O connector, 30
Installation Problems, 30
Installing SCSI Cables Jumpers and Terminators, 11
Installing the Backup Software, 12
interface cable, 4, 11, 12

J

jack screws, 30

L

LCD, 4
Library and Drive Operational Problems, 30
Library Cartridge Change Time, 56
Library Error Messages, 51
Library Indicators/Controls, 56
Library Interface, 56
Library media type, 56
LTO Autoloader, 4, 5, 6, 30
LTO drive, 30

M

Manual Cartridge Use, 3
media cartridge handling mechanism, 3
Media Picker, 3
metal particle tape, 6

N

near-line data storage, 2
Normal Maintenance, 27
Normal Operations, 14

O

off-line data storage, 2
off-line messages, 5
Off-Line Mode menu, 19, 20, 21, 22, 23, 24

off-line mode menus, 5
Off-Line Mode Menus, 19
on-line messages, 5
On-Line Mode, 15, 19
operating environment, 10
operational messages, 4

P

Power LED, 4
Power Up Checks, 15
Powering on the System, 14

R

read/write head, 31
restore operations, 14
Reverse Cartridge Protection, 3
robotic activity, 4, 5
robotics interface, 3

S

SCSI adapter, 30
SCSI Adapter Card Installation, 30
SCSI adapters, 30
SCSI bus, 30
SCSI bus configuration, 30
SCSI buses, 2, 30
SCSI cable, 11
SCSI cables, 30
SCSI cabling, 30
SCSI Cabling, 30
SCSI chain, 7
SCSI channel, 4, 12
SCSI Channel Connectors, 4
SCSI connections, 10
SCSI connector, 11, 12
SCSI device, 30
SCSI devices, 2, 16
SCSI host, 7
SCSI Host Adapter, 2, 7
SCSI IDs, 30
SCSI interface, 2, 3, 7
SCSI termination, 30
Setting the SCSI IDs, 15
streaming tape cartridge, 2
surrounding environment, 10
sustained data transfer rate, 2
switches and indicators, 4

T

tape handling mechanism, 31

U

Use Cleaning Tape warning, 14, 56

V

valid cartridge locations, 3

W

warranty, *ii, iii, 10, 28*
When You Call ADIC's Technical Assistance Center, 53
write-protect switch, 6, 17, 30

Blank Page