

# Scalar 24 快速入门指南

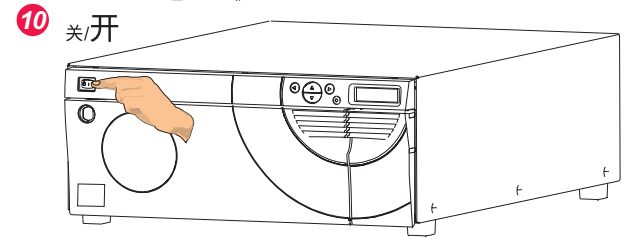

# 所选指示器与控制器

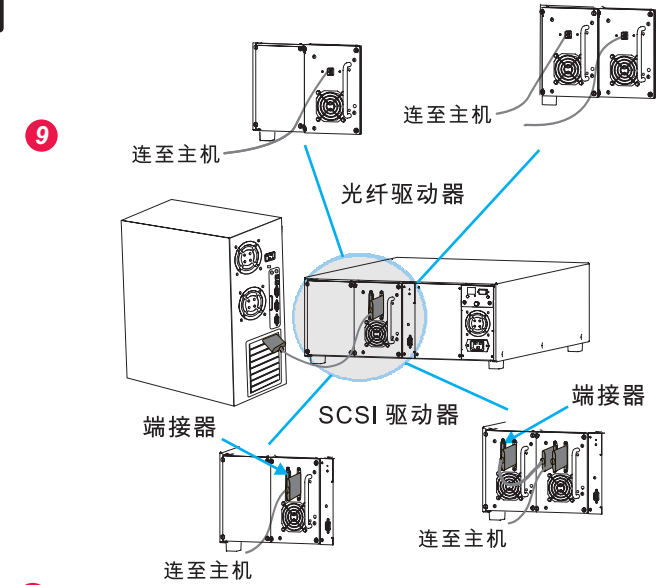
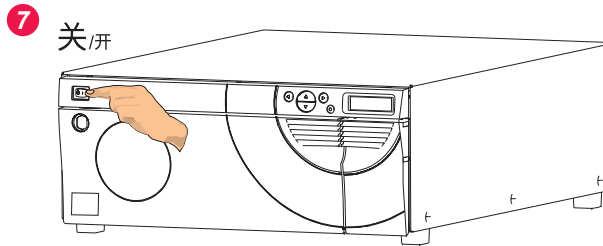
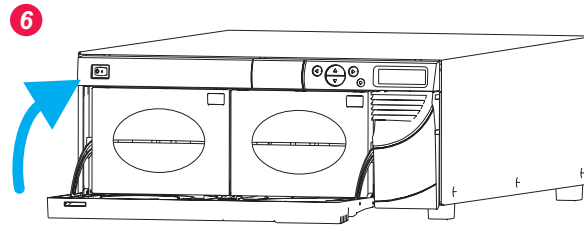
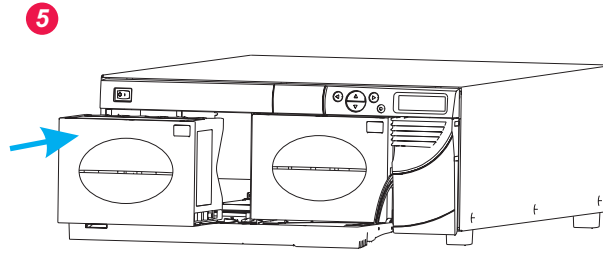
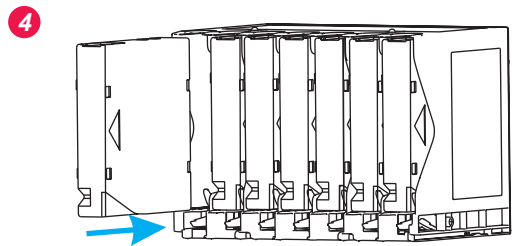
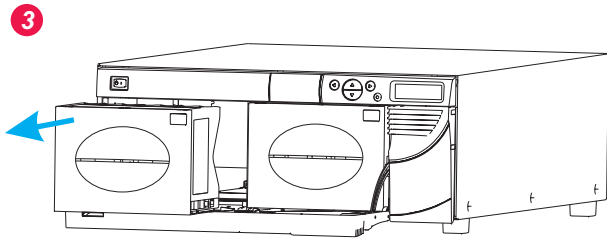
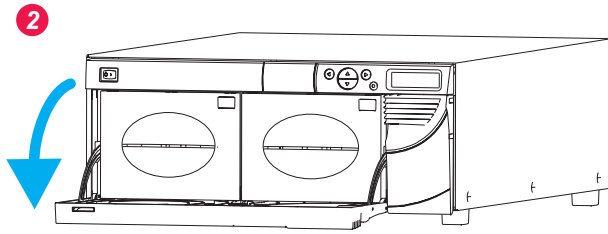
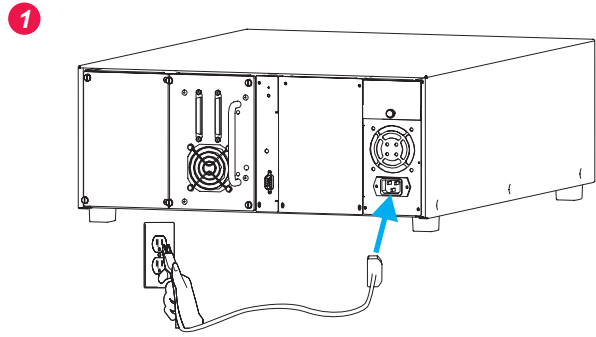
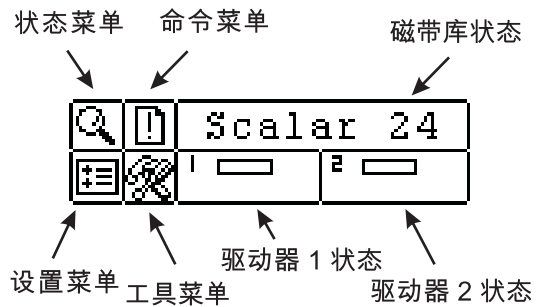

有关操作员面板上可以显示的特殊符号和消息的完整说明，请参阅《Scalar 24 安装与操作指南》的“操作”一节。

有关最新操作系统驱动程序和补丁程序的信息，请访问技术支持网站 [www.adic.com](http://www.adic.com)，或致电 ADIC 技术辅导中心 (ATAC)，电话：800.827.3822 (美国) 或 00.800.9999.3822 (国际)。

## 键盘

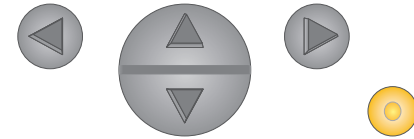

- 按左箭头可向左侧导航菜单。
- 按右箭头可向右侧导航菜单。
- 按上箭头可增大值。  
按下箭头可减小值。
- 按操作键可执行当前菜单选项。